

Cenon
The CAM User's Guide
Version 3.8

by Georg Fleischmann
Copyright © 2002-2007 by vhf interservice GmbH
<http://www.vhf.de>

July 28, 2007

Contents

1	General Information	7
1.1	About this Book	7
1.2	The history of CAM with Cenon	8
1.3	What can you do with Cenon	9
1.4	Other products around Cenon	11
1.4.1	Engravingsystems and Routingsystems	11
1.4.2	Tools	12
1.5	Installation	13
1.5.1	Installation on Linux	13
1.5.2	Installation on Apple (Mac OS X)	14
1.5.3	Installation on OpenStep	15
1.6	Licensing	16
1.7	Initial Operation	17
1.8	Support	18
2	CAM with Cenon	19
2.1	Methodology	19

2.2	Output of a graphic	20
2.2.1	Import of the graphic file	20
2.2.2	Creation of layers - partition in several production units . . .	21
2.2.3	Setting of the tools	25
2.2.4	Assignment of the tools to the layers	27
2.2.5	Positioning of the machine	30
2.2.6	Starting the output	33
2.3	Pick Out	34
2.3.1	Preparation of the graphic	34
2.3.2	Selection of the tools	35
2.3.3	Example	37
2.4	Creation of Reliefs	40
3	Reference part - the functions of Cenon	43
3.1	Preferences settings	43
3.1.1	CAM Preferences	44
3.2	The menus of Cenon	46
3.2.1	The Document-Menu	46
3.2.2	The Format-Menu	47
3.2.3	The Tool-Menu	48
3.2.4	The Display-Menu	49
3.3	The CAM-Panel	51
3.3.1	Layers	52
3.3.2	Tool Management	60
3.3.3	Machine-Control	65

<i>CONTENTS</i>	5
3.3.4 The Positioning Memory	68
3.4 Layers	69
3.4.1 The Clipping-Lage	70
3.4.2 The Fitting Layer	75
3.4.3 The Levelling Layer	76
3.5 Barcode Import	77
4 Device Configuration	81
4.1 General Information	81
4.1.1 Creating your own configuration files	81
4.1.2 Important Notes	82
4.2 Output Devices (CNC controller)	84
4.2.1 General Information	84
4.2.2 Commands in the configuration file	84
5 Appendix	97
5.1 What you should know about tools	97
5.1.1 Reasons for more cutting edges	97
5.1.2 Reasons for few cutting edges...	98
5.1.3 Cross Section:	98
5.1.4 Working Parameters	99
5.1.5 Geometry and Dimensions	101
5.1.6 More Information / where to buy tools	102
5.2 Files and directories	102
5.2.1 Cenon program	102

5.2.2	Library	103
5.3	Error and Warning Messages	104
5.4	Keyboard Commands	108
5.5	Frequently asked Questions	110
5.5.1	CAM	110
5.5.2	CAM Production	111
5.6	Serial Cable	113
5.7	Glossary	114

Chapter 1

General Information

1.1 About this Book

This documentation serves as a reference of the CAM functions of Cenon. It is ment as a reference guide as well as a working guide.

Depending on your computer system (Linux, Apple) or the applied Theme (skin), there are differences in the look of the user interface. The panels depicted in this book may differ in their look from the interface you are using, although the placement of the controls remain identical.

The various computer systems (Linux, Apple, OpenStep) also show some differences in the directory structure. This information is always given for all systems.

This book was created using LyX on Linux. The colorful cover page was designed using Cenon.

All trade marks like PostScript, Adobe Illustrator, HPGL, DXF, Gerber, Excellon, Sieb&Meyer etc. belong to the respective owners.

1.2 The history of CAM with Cenon



CAM is how Cenon started in the first place at the end of 1992 and is one of the major strength of Cenon. As recently as in the year 2000 with the beginning of the restructuring of Cenon for the new platforms Linux and Apple, Cenon was converted to its new modular layout.

Since version 3.60 of Cenon, the CAM functions have their own module. This gives Cenon a great new flexibility. The CAM functions have gained by this step and were improved greatly.

With the separation of the CAM module it was possible to make Cenon free software, making it available for a large audience. With this step we hope to improve the quality and spread of Cenon in a way not possible before.

1.3 What can you do with Cenon

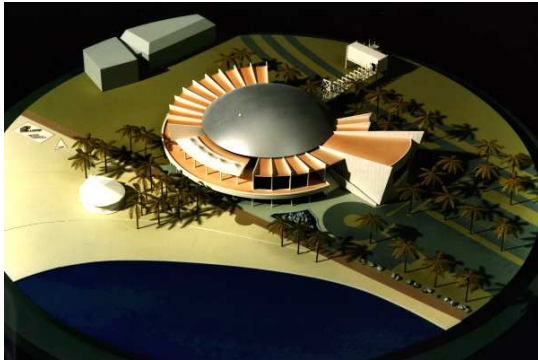

(model created with Cenon)

CAM was the first application of Cenon. That is how Cenon started. Since 1993 this important application of Cenon has been continual enhanced and improved. Today, Cenon is at home in almost all areas of CAM. From engraving of name plates, signmaking, to industrial serial production reaches the base of installations world wide.

Key Features

- automatic tool radius correction to inside or outside
- Pick Out function for high precision engraving
- Relief function on raster images for production of three-dimesional relief images
- Drills, threads, sinkings
- Stepwise processing of dipping depth in flexible steps
- optional settlement
- Webs to support parts during manufacturing

- selektive processing
- Precise interactive positioning of machine
- Teach-In
- Tool management
- Output on HPGL- and DIN-66025 compatible devices
- expanded User Guide

Examples of applications

- Sign making (Milling, engraving, cutting of any kind of advertisings)
- Engraving (door signs, goblets, coining dies, ...)
- Industrial engraving (type plates, labels, signs ...)
- Electronic (front panels, switch boards, prototypes of printed circuit boards ...)
- Model Making (models of buildings, industrial appliances ...)
- Fine Machanics
- Cutting of sandblast foils or cutting of foils for polishing optical glasses
- Production of individual operation panels
- Cutting the contour of single CDs
- Production of dashboards
- you name it

1.4 Other products around Cenon

This chapter introduces some products and services around Cenon.

1.4.1 Engravingsystems and Routingsystems



vhf camfacture offers engraving- and milling machines, which work perfectly with Cenon and make lots of fun, if you like really hand-screwed applications.

All vhf systems offer 3 full axes, which can be positioned independently. Therefore the machines are ideal for engraving as well as drilling and milling. The precision of 1/100 mm grants for exact results.

The modular construction of the machine allows assembly for your special requirement, and keeping future extensions open. Even existing machines can be extended with vhf components.

Take a look at the web site (<http://www.vhf.de>) or contact vhf camfacture directly.

1.4.2 Tools



What would be the production without tools. vhf manufacture did a great job and provides carbide tools in their internet shop since 1997. You can get there everything making chips, and shipping is world wide.

Go to <http://www.carbide-tools.com> to find tools and related stuff. You will also find a free service calculating the right revolution and feed for your tool and material.

1.5 Installation

The installation process for Linux, Apple and OpenStep differs slightly. Please read the section for your System.

Here we describe the installation of the executable packages only. If you want (or need) to compile Cenon yourself, take a look at the file INSTALL inside the source tree.

1.5.1 Installation on Linux

1. log in as user root
2. Insert the Cenon-CD and mount the CD. Then change to the directory 'Linux▷i386▷CAM' or 'Linux▷ppc▷CAM', depending of your architecture. If you downloaded Cenon, you can skip this step.
3. You will find a RPM package. Install it with the installation tool of your Linux distribution, or enter the following command in a terminal shell:

```
rpm -Uhv Cenon*.rpm
```

4. To start Cenon go to the folder /usr/GNUstep/Local/Applications and start Cenon with a double click. If you don't have GWorkspace running you can start Cenon by typing 'openapp Cenon' from a shell.

If this is your first installation, Cenon will ask you for a license key.

1.5.2 Installation on Apple (Mac OS X)

1. Insert the Cenon-CD and wait until the CD-Symbol appears in the Finder. Then click on the CD-Symbol and goto into the directory 'Apple▷Packages▷CAM'. If you downloaded Cenon, you have to unarchive the downloaded file instead (double click).
2. You will find a package with the name Cenon.pkg. Double click the package to start the installation.
3. The installer appears, where you have to authorize yourself as administrator.
4. Then you can start the installation process by confirming the different stages (Introduction, Read Me etc.). The files are now extracted from the file and copied to your hard disk. This takes a few moments.
5. If you have a previous version of Cenon already installed, the install programm will notify you. Just continue the installation.
6. After the package is installed, you can start Cenon. To do this, go to the directory '/Applications' and start Cenon with a double click.
If you have installed Cenon the first time, the license panel appears. Here you can license the program, or you can run Cenon in demo mode.
7. Your CNC controller usually has a serial interface to be connected to the computer. Since newer Apple computers doesn't provide a serial interface, you need an USB adaptor - usually this is a adaptor from Keyspan:

<http://www.keyspan.com>

Install your Keyspan adapter and the driver software as given in the adaptor documentation. To be sure that everything works, you can use the 'Serial Assistant' coming with your Keyspan adaptor.

If you have problems, you can check the device entry (#DEV) in the Cenon device configuration (Kapitel 4.2). The device entry must be equal to the device created by the USB adaptor (/dev/tty.USA...). The devices in the Cenon configuration provide a wildcard '*' to allow automatic device expansion.

Tip: If it happens that the serial device hangs (e.g. no device is connected), than you can unplug the USB adaptor to regain access. You can use the cu device instead of the tty device to avoid the hanging of the device and Cenon in this case.

8. To come into the pleasure of importing PostScript or PDF files, you have to install GhostScript. You can get a version of GhostScript from the same place where you got Cenon, but any other version of GhostScript will do the job. Double click on the GhostScript package to start the installation.

1.5.3 Installation on OpenStep

1. Log in as user root
2. Insert the Cenon-CD and wait until the CD-Symbol appears in the File Viewer. Then click on the CD-Symbol and go into the directory 'Apple▷Packages▷CAM'. If you downloaded Cenon, you have to unarchive the downloaded file instead (usually a double click should work).
3. You will find three packages, which you have to double click one after the other. The names are:
 - (a) Cenon.pkg
 - (b) CenonLibrary.pkg
4. For each package a window will appear, where you have to click on Install.
5. Then another window appears. Just click on Install or press Enter. The files are now extracted from the file and copied to the hard disk. This takes a few moments.

If you have an old version of Cenon already installed the install programm will notify you. Just continue the installation.
6. Wait until the first package has been finished before installing the next one.

7. After all packages are installed start Cenon as user root. To do this, go to the directory '/LocalApps' and start Cenon.app with a double click.

If you have installed the CAM version of Cenon for the first time, the license panel appears. Here you can license the program (See the next section) or decide to run it in demo mode.

1.6 Licensing

In the Info menu of Cenon you can call the licensing panel. The first time you start Cenon it will appear anyway.



In the following panel you can see the id of your computer. Please send this id to vhf to get a password.



The image shows a 'Cenon Registration' dialog box. The title bar reads 'Cenon Registration'. The main title is 'Registration Form'. The form contains the following fields and buttons:

- Id of your System: 100072
- Password: [Empty field]
- Name: [Empty field]
- Organization: [Empty field]
- Street: [Empty field]
- City: [Empty field]
- Country: [Empty field]
- Buttons: Demo, Cancel, OK

Please enter (or copy) the password into the password field. Then enter your name and address.

Finish the licensing process with a click on OK.

1.7 Initial Operation

You will find Cenon in the application folder. Double click on the Cenon.app to start Cenon. The CAM module will be loaded automatically.

In the library folder of Cenon you will find some examples: The folder '*CAM/Jobs*' provides some examples of Jobs.

The library of Cenon resides in slightly different places, depending on your system:

OpenStep: /LocalLibrary/Cenon

Apple: /Library/Cenon

GNUstep: /usr/GNUstep/Local/Library/Cenon

1.8 Support

- User guide We try to keep the user guide practical and full of information. The user guide should answer most of your question.
- WWW You can find information about new versions and an up-to-date FAQ (frequently asked questions) on our Website:
<http://www.cenon.info>.
- Mailing list In the mailing list of Cenon, you can ask questions and exchange yourself with other users of Cenon. To subscribe to the mailing list you can go to the Support page of the Cenon internet site.
- eMail Direct support for the CAM version is offered by vhf camfacture. The best support is possible by eMail, as you can attach example files easily here.
- Bugs If you find a bug, we are thankful to receive your bug-report. We will try to fix serious bugs for the next release.

Chapter 2

CAM with Cenon

2.1 Methodology

In the following we will give you a short overview of the fundamental procedures for the output of a graphic. In the following sections you can find detailed information about all the (possible) operations.

- Import of a graphic
- Creation of layers for every necessary operation Distribution of the graphic to the right layers.
- Setting of the tools that you want to use.
- Allocating of the tools to the layers. Setting of the dip depth.
- Positioning of the machine. Starting of the output.

2.2 Output of a graphic

In the following we show you all the single operations to work with a graphic file on your milling and engraving machine. Our example is an imported graphic-file that is not edited.

Editing: The editing-functions of Cenon are described in the Cenon main book beschrieben.

2.2.1 Import of the graphic file

First you have to load the file. It can have Postscript (EPS or AI), HPGL, DXF, Gerber or DIN format. Cenon recognizes the format automatically. You only have to choose the command "open" in the file-menu and select the right file from the graphic-file-window.

Menus: The description of the several menus you can find in section [3.2](#). and in the Cenon main book

For our example we want to load a Adobe-illustrator file. This file belongs to your delivery extent of your Cenon version. It is installed automatically in the library path in the home-register of the user. Go to path: Library/Cenon/Examples/ai and load the file "high tension.ai" that looks as follows:

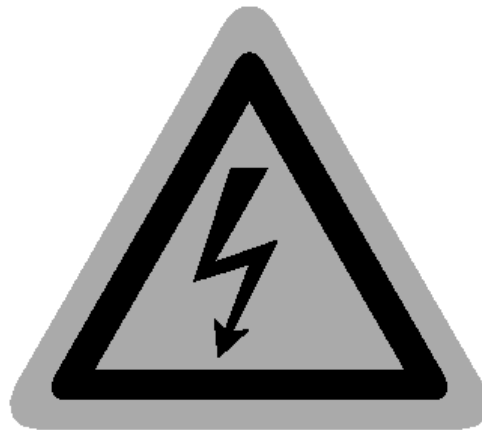

2.2.2 Creation of layers - partition in several production units

Several production steps are necessary to work with such a graphic file on your engraving machine. In this case there are at least two - the engraving of the flash and the bordering and the milling of the sign out of the basic material. These different operations are distributed by Cenon to different layers.

First you can choose another color for the grey graphic-file. Open the inspector. It offers you information about the selected graphic-file and you can alter it. You can find the inspector in the menu tools (entry inspector). When no element is selected the inspector shows the position of the crosshair. Click on the outer contour of the graphic. In the inspector a field appears that shows the color of the selected element (here light grey).

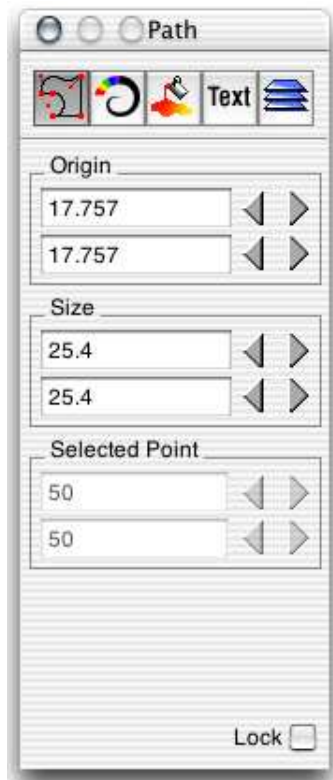

Inspectors: You can find further details about the inspector in the Cenon main book.

Click on the outer frame of this field. You get the Color-Panel with different options (you get the same window when you choose the entry colors in the menu tools). Here you can choose a shining yellow that suits for a warning signal.

Although black would be o. k. for the flash and the frame it's better to choose a brighter color because Cenon shows the ways of the tools also in black. To be able to see the difference it's better to choose grey.

After you have chosen the colors it's time for the CAM-Panel to separate the different operations. Open the CAM-Panel in the menu Tools (if it's not open already). The CAM-Panel consists of "index cards". When you click on the name of one index card it is taken to the foreground and you can start the setting.

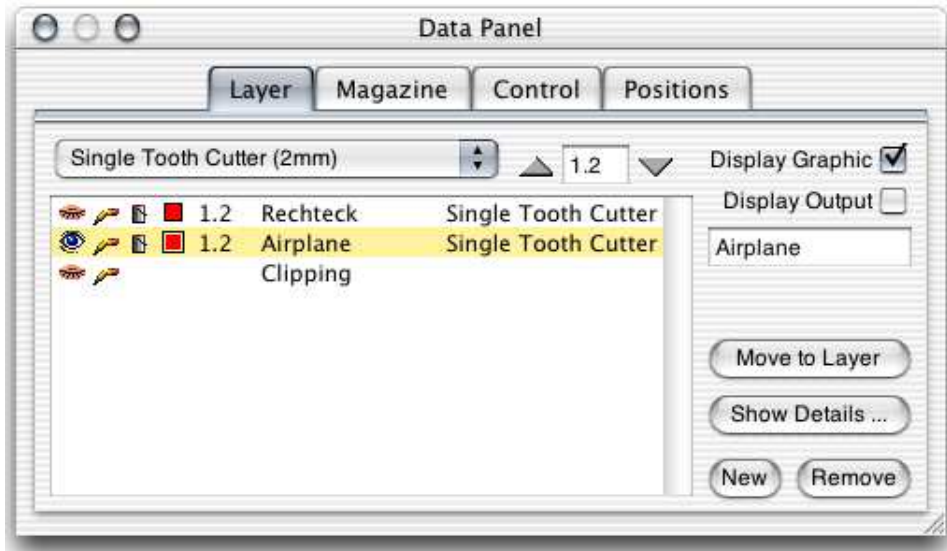

To separate the operations to the different layers you have to choose the index card layers. With this panel you manage the layers, say the different operations of your graphic file. At first there is only one layer in the layer panel which is called : no name. On the left in this bar/line there are 4 different icons with which you can influence the design and the path calculation. The numerical value on the right next to the icons indicates the dip depth of the tool, on the right you can see the name of the layer and on the right to the layer you can see the selected tool (in this case you cannot see a tool yet because none has been selected yet).

 0 Lage 1 vhf RubOut 1.0 mm

The name of the layer (here: Layer 1) should describe the respective operation. In this case you can enter e.g. "milling" for the layer that contains the outer contour (don't forget to confirm the input with "enter"). You can edit the name in the small field on the right of the window. Then you have to create a second layer that contains the engraving. Click on the button new and you get a further layer. You have to give this layer a new name, too, e. g. "engraving".

Now you can select the elements you want to engrave in the graphic window, the frame and the flash (by pressing the Shift-key during this selection you can choose

more than one element (at the same time). Then you can select the second entry (engraving) in the layer-panel and click on Move to Layer. This will move the selected elements to the current layer. Now you have separated the two operations milling and engraving successfully.

You can let Cenon carry out the operation for you (distribute the different elements with different colors on different layers. Therefore you have to switch on the button import colors on the layers in the window preliminary settings before you import the file (you get to the entry preliminary settings from the menu information.)- So you can spare a lot of effort later.

Now you can set some further parameters; therefore you can use the icons.

 The eye on the left shows if the layers are displayed/shown. When the eye is closed the layer is not shown. Especially for control purposes we recommend to fade out some of the layers to be able to check whether the single elements are on the right layer.

 With the small pencil you can decide whether a layer is editable or not. When you break the pencil you cannot change/transform/alter the layer any longer. So it is also protected from unintentional actions.

 With the color-pot you can decide whether the output of the layer should be filled or not. In our case the engraving layer has to be filled (poured-out pot) and the milling layer (outer contour) is not filled.

 You can set the radius-correction with the last of the four icons. For the milling layer you have to carry out an outward correction and for the engraving layer an inward correction. It's important that you choose the same diameter for the tool as for the operation later because the radius correction and the calculation of the filling algorithm goes by the diameter of the chosen tool.

Some of the setting possibilities (and other special settings) that you can carry out with the icons you can also find in the window layer-details (you get there with the details button). When you click on layer in the layer-details-panel you get back to the layer-panel. But first you should set or check the needed tools.

Details: You can find further details about the Layer-Panel in section [3.3.1](#).

2.2.3 Setting of the tools

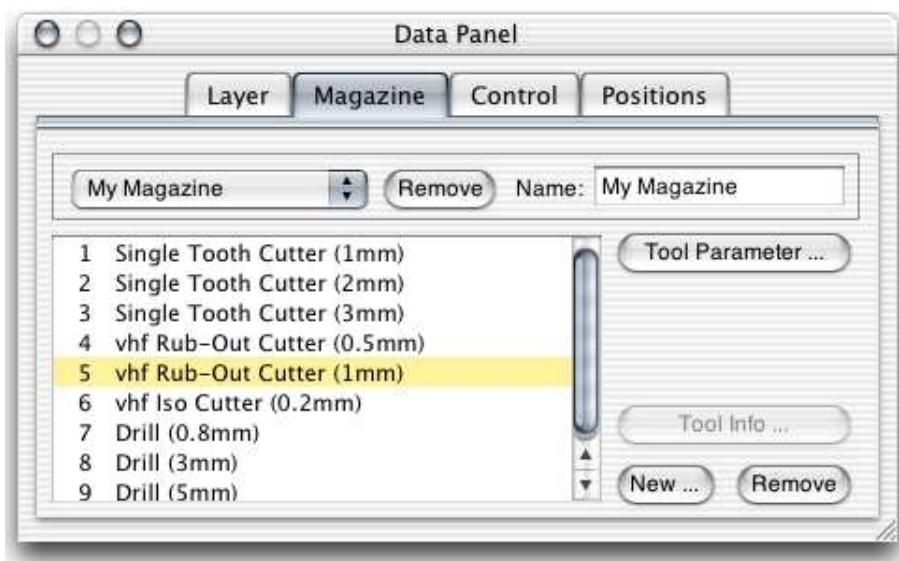

This panel shows the content of the current tool-magazine. Here you can delete existing tools and add new tools. With the pop-up-menu you can choose a different tool-magazine and from there you can select a tool for the next operation. The tools go by the ability to carry out a tool-change automatically (see plot-magazine).

When you click on parameter you can see the characteristics of the selected tool and you can adapt them if you want. In any case you have to check if our set parameters correspond to the actual values of your tools. If not change it according to the instructions.

When you use different tools you should also mind that all the tools must be chucked in in the same height. Otherwise you have to set the z-position newly after every tool-change because you define the scratch-height with the z-contact value in the disposition-control-panel. Use only tools with stopping ring that are assembled in

the same height if possible. If this is not the case with every tool you have to do the following:

Click on the button parameter in the Magazine-Panel. The following panel will show up:

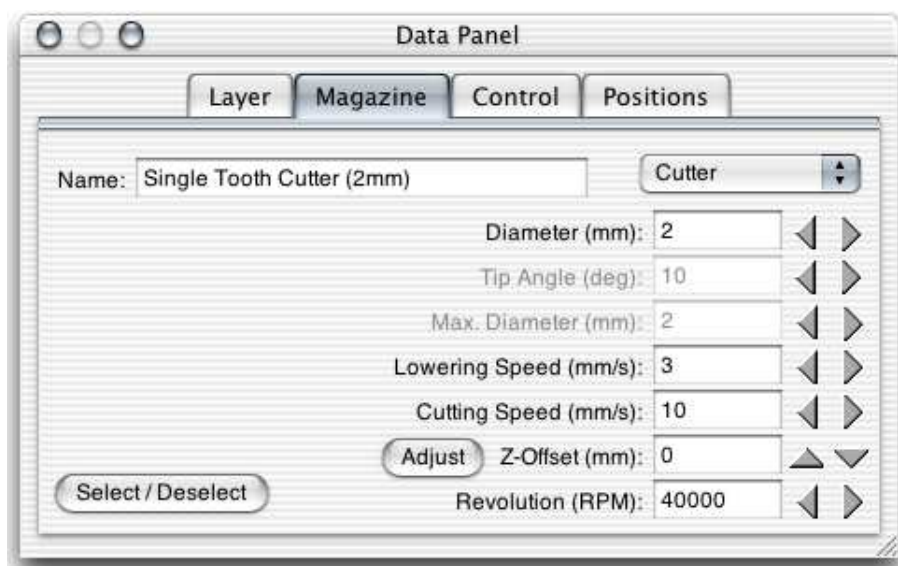

Here you can find the entry z-offset (among other entries). With this entry you can enter the difference of the height to the biggest tool (the value z-contact has to be fixed with this tool). If the longest tool is 38mm from the stopping-ring to the top and the actual tool is only 30 mm you have to enter 8 to the z-offset. You can use the adjustment button to determine the scratch depth by trying out.

Details: You can find further details to the tool-panel in section [3.3.2](#).

Tools: Interesting information about the tools, the selection, the calculation of the rotary frequency, forward feed you can find in section [5.1](#).

2.2.4 Assignment of the tools to the layers

After the adjustment of the tool parameter you have to assign a tool to every layer and adjust its dip depth into the material. Therefore click on the Layer-Panel again.



On the right next to the red icon for the radius-correction is a numerical value (presently:0). This value indicates the dip depth directly from the surface into the workpiece. For the engraving some tenth of a mm is enough to get through the topmost layer of the material. You can adjust the dip depth either with the help of the two arrow buttons or you can enter the numerical values directly in the field between the two arrows. For the layer that is milled you have to enter the thickness of the material so that it is completely cut during the milling operation.



With the pop-up-menu next to it you can select the tool with which the next operation should be carried out on your engraving machine. Mind that you enter the right tool diameter because it is needed for all the calculations. All the tools that are in the actual magazine are shown.

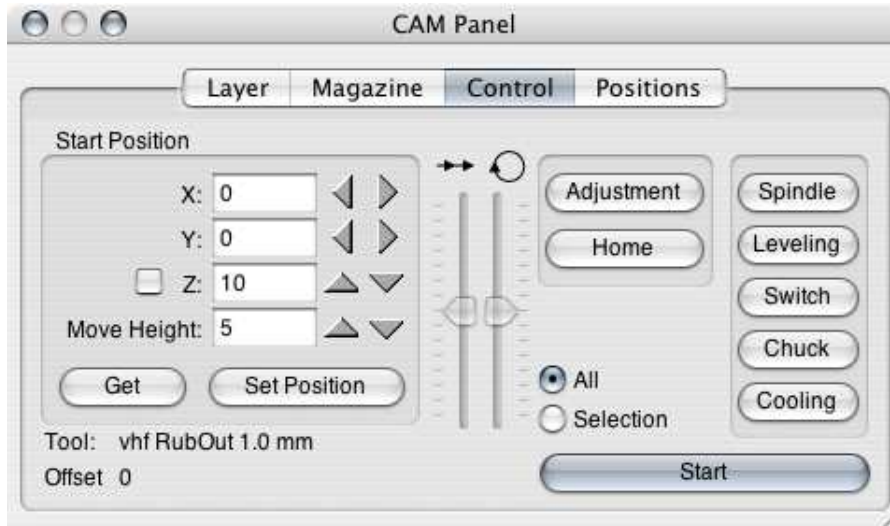

When you finally click on output in the Layer-Panel you can see the drive-ways that were calculated by Cenon. They lay black over the original graphic. If it's hard to see the drive-ways it might be better to enlarge the display. Therefore you can find a pop-up-menu on the lower border of your graphic window with which you can choose the zoom-factor. The best way might be to click on the magnifying glass. Then you can drag up an area of the graphic window that is enlarged to the whole size of the graphic window.

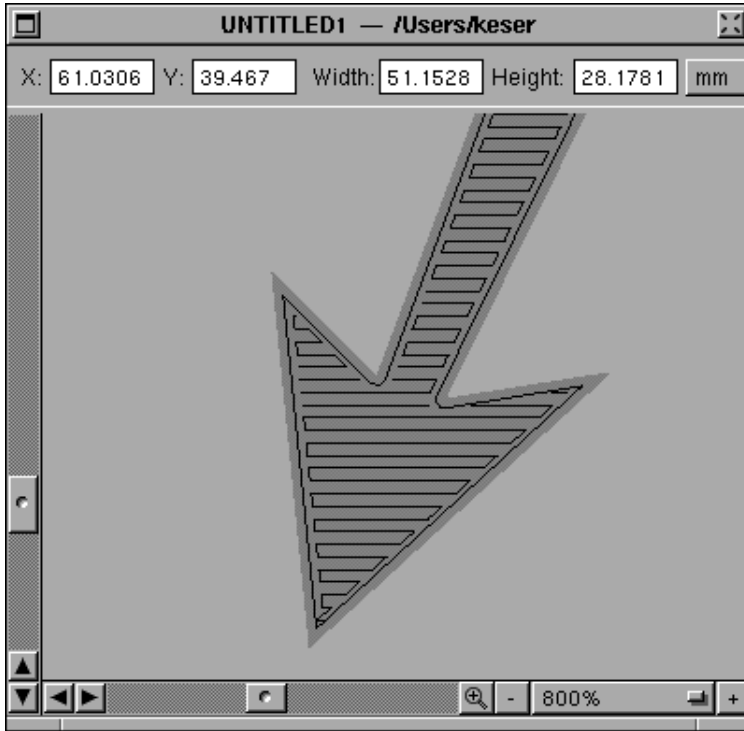

Graphic window: Further details about the graphic window you can find in the Cenon main book.

Your Layer-Panel should look almost like this when everything is correct:

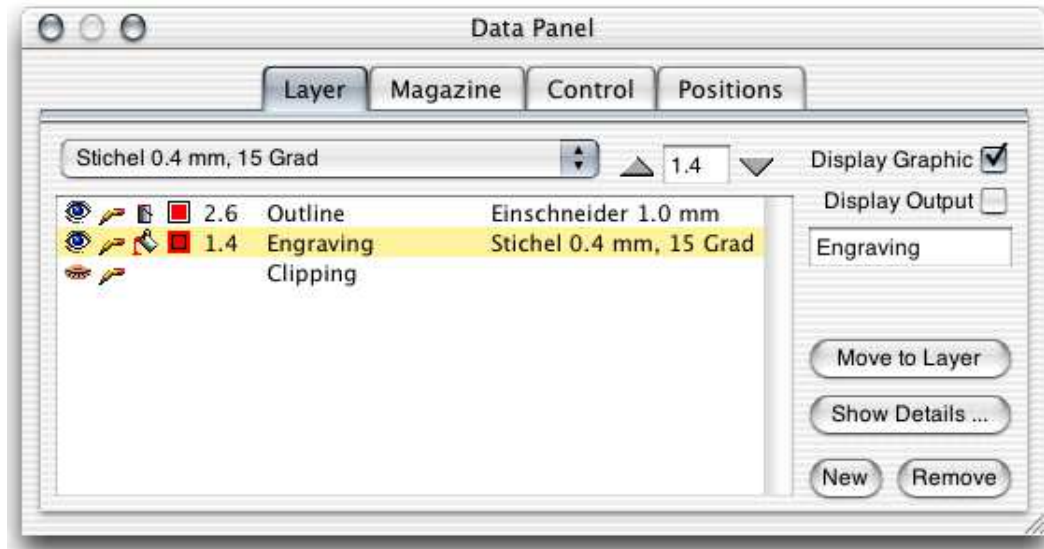

2.2.5 Positioning of the machine

Now the preparation is finished and we can now start to go into production of our graphic: take an appropriate multilayer plastic board (we recommend to take one with a yellow top layer and a black basic layer). Now you can chuck the board onto the engraving machine.

Now we come to the third part of the panel namely the machine Control. Click on the appropriate index card and your window looks like that:

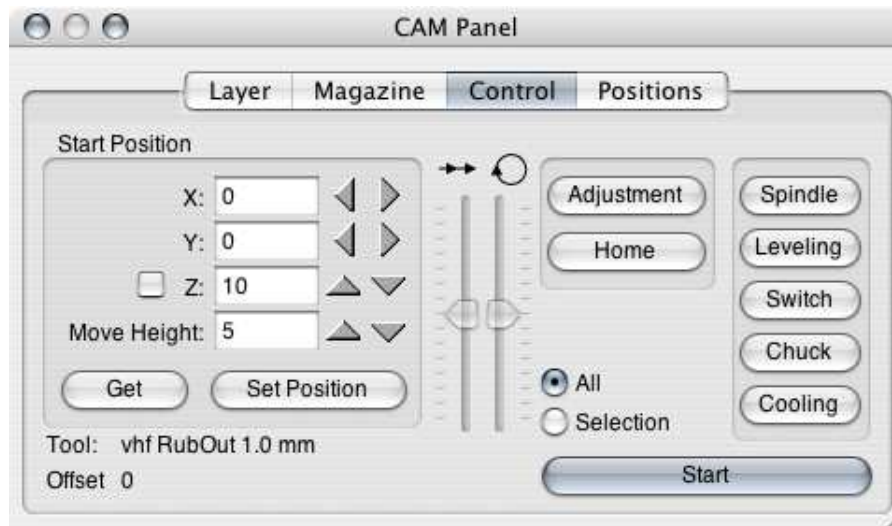

In the machine control you set the starting point where the machine is supposed to start the operation on your workpiece. You can move the machine directly when you click on the appropriate arrow buttons. If you want to enter the positions manually don't forget to press the Enter-button to drive towards the position. But Attention: as soon as you press Enter or click on Set Position the machine moves to the given position. If you give a wrong position (especially for z) this could lead to damage of the spindle or the workpiece.

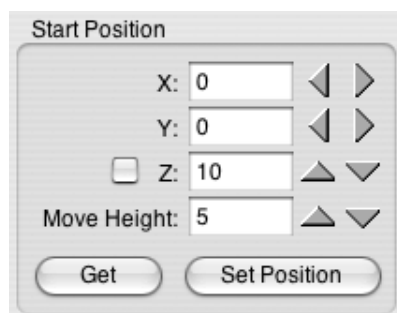

That means it's better to set the starting position with the arrow buttons for X, Y, and Z. Move X, and Y to the lower left of your working piece, then lower Z down to the surface, so the surface is almost scratched but isn't. When you click on the arrows

and press the Ctrl-key at the same time the machine is positioned in 1 mm steps.

The move height (or flight level) should be set to a secure value. This is the height the tool will move above the surface of the working piece.

Use the memory for the positioning! Especially when you have a lot of workpieces of the same size we recommend to justify the workpieces at the side stop and take the saved starting position when you work with a workpiece of the same size.

To save a position move to the starting position in the machine Control-Panel. The choose the index card Positions. Now you are in the position-memory management.

Click on the pop-up-menu and choose the last entry New Position. Cenon takes over the current position from the Control-Panel and calls it: UNTITLED. You can edit this field and give it a proper name. Later you can recall the saved position , watch it and finally move the machine directly there by clicking on Set Position.

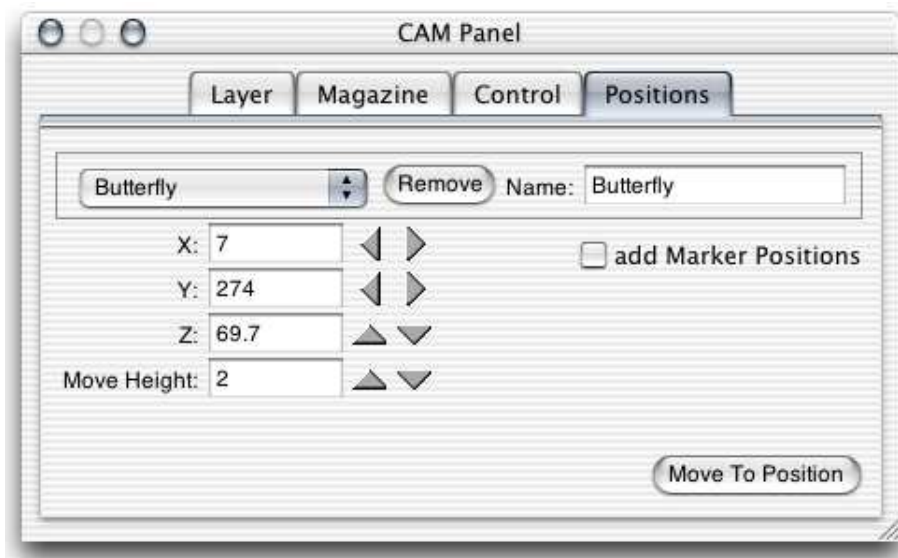

As we already mentioned please mind that the Z-position is not too low when you move to saved positions (e.g. when you use another pad). After you have clicked on "move to the position" you get back to the Control-Panel automatically.

Details: Further details about the Control-Panel and the position memory you

can find in section [3.3.3](#).

2.2.6 Starting the output

Finally you can work with/on the workpiece. With the start-button the output starts/begins. Before it'll begin it'll ask you to chuck the appropriate tool. Therefore the z-axis moves to the zero position.

Depending on the system you use Canon will start the spindle automatically after you have chucked the tool and left the dialogue box. If your spindle is not equipped with an automatic start you must switch on the spindle before you press OK in the dialogue box!



The machine starts to work on the workpiece. The machine starts to work according to the sequence of the layers you have set in the layer-panel. that means in this case the machine starts with the outer contour.

If you want to change the sequence act this way: the machine only works on layers with open eyes. When you want to start the output with the outline shut the eye of the milling-layer and start the output. In a second operation you can open the eye again and shut the eye of the engraving-layer.

A second possibility to give out only special elements is to select the wanted elements in the graphic window. Then choose the entry selection in the layer-panel. If you press start only the selected element will be given out.



When the machine is ready after an operation the z-axis moves back to zero-position and asks you to change the tool until all the layers are ready.

2.3 Pick Out

The function Pick-Out was developed for the manufacture of stamps. Therefore you have to mind a few things.

2.3.1 Preparation of the graphic

The pick-out will clear the black fields of the graphic. That means you have to create a negative picture of your graphic. Your graphic appears then in white color on a black background. The black background is cleared while the graphic is filled. The outline of the stamp must lay within the negative graphic so that only the original graphic remains raised.

You can also calculate the drive-ways for **raster images** (e.g. TIFFs) during the pick-out. To get a good result you have to scan the graphic bigger than how it should appear later. In the Cenon program you can reduce the size to the original size again. You should scan the graphic at least 4 times bigger than the original size so that Cenon is able to work with it. After you have dragged your graphic into the graphic window you can start scaling the graphic in the transformation panel (menu work, entry transform).

The bigger you scan your graphic the more exact is your result but also the longer is the calculation-time. You need a negative picture of your graphic here, too.



2.3.2 Selection of the tools

The Pick Out corresponds mainly to the inward tool-radius-correction. Additionally the tool is raised in the edges and in parts that are too small to create an exact picture of the graphic on the material best as possible.

The right choice of the tool plays a very important role because the Pick Out can only be carried out with conical tools. Four values are decisive for the choice of the tools:

- maximum diameter
- diameter
- acute angle
- wanted dip depth

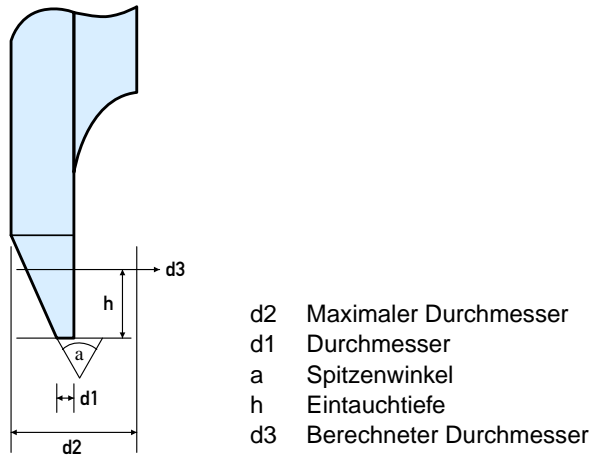

Cenon calculates the effective diameter ($d3$) of the tool from the dip depth (h). The drive-way is calculated with the effective diameter ($d3$). When we come close to an edge the way to the edge is searched and the diameter ($d3$) is reduced as necessary by lifting the tool. The maximum accuracy in edges is determined by the diameter ($d1$). The same goes for passages that are too small for the maximum diameter ($d2$); the diameter is reduced until it is small enough to go through this passage.

The tool is supposed to get through every passage with the effective diameter ($d3$) (calculated with the dip depth) so that the tool has only to be lifted in the edges. Too small parts on the graphic should be avoided if possible.

2.3.3 Example

The example of a stamp will show a practical example. The stamp has an original width of 34 mm and a text height of approximately 4 mm.

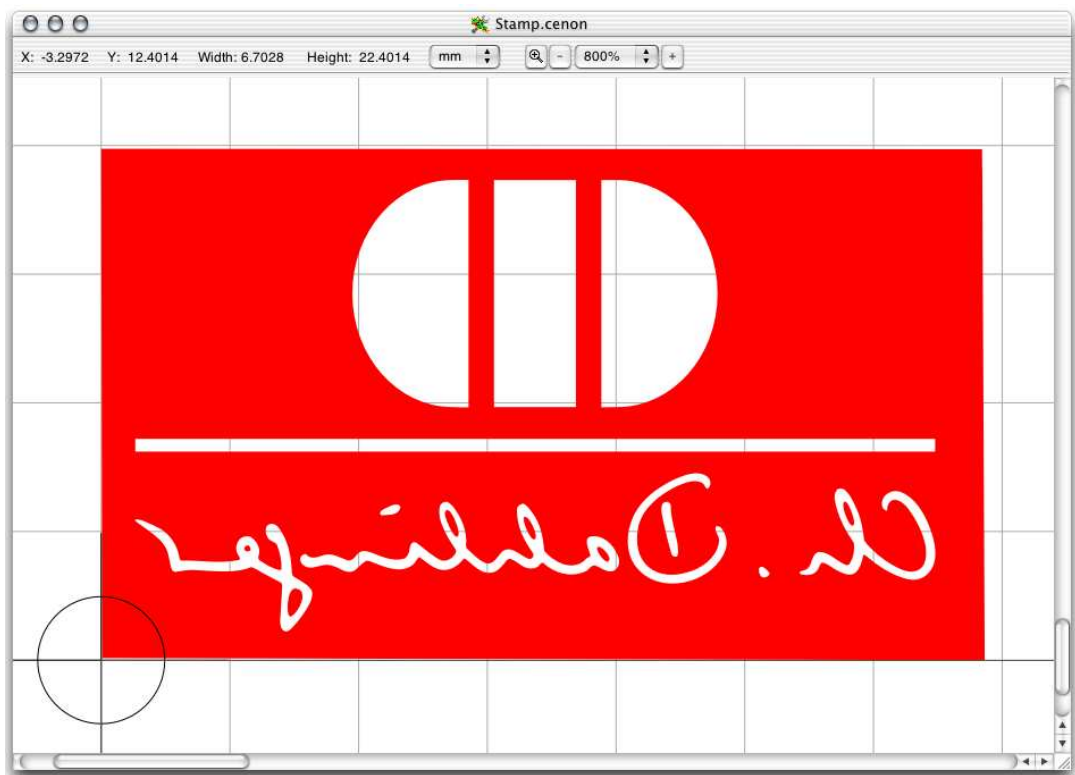

As

we want to make a stamp, the motive is mirrored. The red areas in the example will be removed, the white text will remain.

Layers and Tools



The PickOut offers two layers. The first layer is responsible for the actual pick out process. The second layer is filled and makes the rubout.

In the example a conical tool is used with 0.2 mm tip diameter and a tip angle of 36 degree. The first tool must be conical!

For the filling, the example uses a conical tool too. It has a tip diameter of 1.0 mm and 36 degree tip angle. The tool for filling may be cylindrical.



The result is a complex fill pattern. The images shows the engraving tracks of an enlarged part of the screen. The three processing steps are clearly visible:

1. rough filling using the filling tool
2. fine filling using the pick-out tool
3. pick out

2.4 Creation of Reliefs

Using the Image Inspector you can enable the relief function for an image. If you set the relief switch, the output is calculated as a relief with Z representing the grayscale.

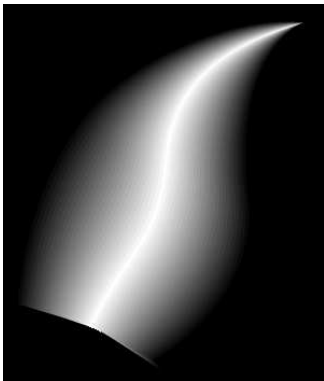

The colors of the image now represent a Z-level. Black color is rubbed out using the dip depth assigned to the layer (see section 3.3.1). For white color the material is not touched - the cutter moves at surface level. The graphic is processed in rows and columns with varying depth. All colors between are graduated in three possible ways:



Here you can select the kind of graduated processing of the image:

Linear	The gray levels are processed in a linear way
Circular	The gray levels are processed in a way that a linear graduation results in a circular cutting of the material.
Logarithmic	The gray levels are processed logarithmic.

The image used for producing a relief should be a grayscale image in a rather high resolution (e.g. 300 dpi). After importing the image into Cenon, you have to scale down the image to the needed size (the tool diameter should cover several pixels of

the image now). As a rule of thumb, the image should be reduced at least by a factor of three. To do that you can use the Image Inspector or the Transform-Panel. The thinner the tool you use, the more you have to reduce the size of the image to get the best results.

Chapter 3

Reference part - the functions of Cenon

3.1 Preferences settings

You can reach the preferences panel with the menu entry 'Preferences' from the menu 'Info'. Here you can set basic settings for Cenon and its modules. The Cenon preferences are placed in different tab pages, which can be selected by the row of icons on top. The icon to set the CAM preferences displays a CNC machine.



3.1.1 CAM Preferences

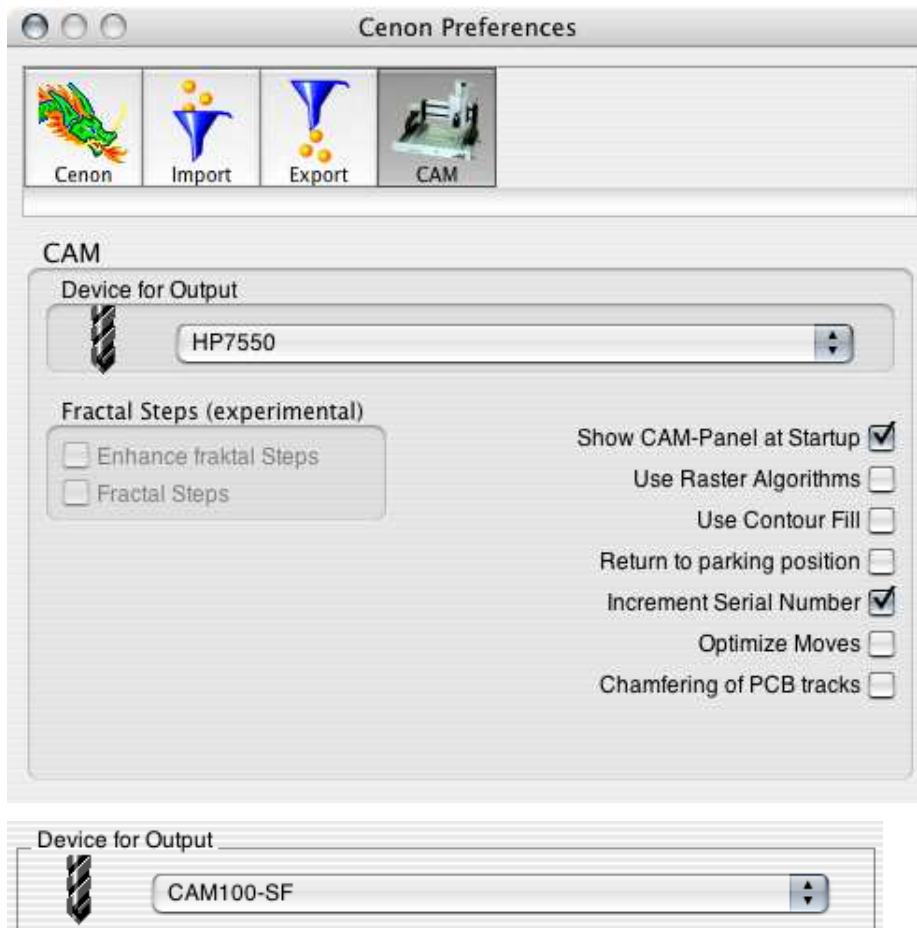

In this pop-up-menu you have to select the appropriate parameter-file for your machine. Please have a look at section 4.2 for the creation of your parameter-files or the adaptation of existing files.

Show CAM-Panel at Startup

This option determines, whether the CAM panel will be displayed at start-up of the application.

Use Raster Algorithms

This uses raster algorithms to render the output paths. This takes more time and is usually of less quality. However, if you have extreme data, this option will calculate what the normal algorithm can't.

Return to parking position

Here you can enter whether the machine should move back to the starting position after the output of your data or not. Otherwise it'll stop at the last entered coordinate.

Use Contour Fill

Activates the contour fill algorithm, and disable the normal fill algorithm. The contour fill fills along the contour of the graphic, instead of moving back and forth. Usually the normal fill is faster on most machines, but the contourfill might look better at the end.

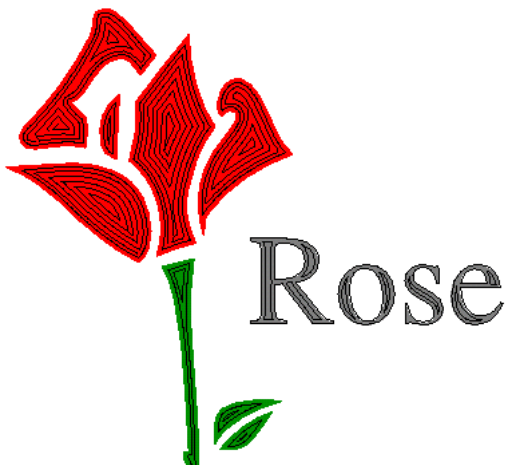

Increment Serial Number

Enable this entry, if you want Cenon to increment your serial numbers automatically after each output. This works for batch production as well as for single peaces.

Optimize Moves

If you enable this option, the moves between the objects are optimized automatically. As this prevents yourself of adopting your own order, you can disable this feature. You will still be able to let Cenon optimize the moves by using the menu entry (Format▷Optimize Moves).

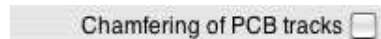

If this switch is activated, the isolation tracks of PCB prototypes will be chamfered. This means, that tiny copper chips are removed at positions with sharp angles.

3.2 The menus of Cenon

In this section we will describe the functions in the order of the entries in the menu. When you look for a special information about a special entry you can surely find it here.

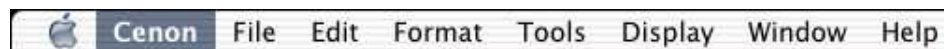

3.2.1 The Document-Menu



Open Barcode

With this menu entry you can load jobs via a code, for example a barcode. The menu entry does only exist, if

the corresponding feature is configured. See section 3.5 for more.

Import ASCII...

Here you can load an ASCII file. This can be used to produce different signs of the same geometry in a mass production. The function is already explained in the Cenon Reference Guide.

Save Output...

Here you can save the data in a file instead of sending the output directly to a machine. The same setting and starting positions are used (as when you send it directly to an output-machine).

3.2.2 The Format-Menu



Bring to Front

Send To Back

With this menu items you can move objects to the foreground or background. So you can influence the sequence of the display. When an object cannot be selected because it is hidden, you can put on the others with this command.

The selected graphic object can be send all the way to the back or front, or just a single graphic object further to the back or front.

The order of the graphic objects determindes the order objects are process on output. If you have enabled the automatic optimization of the output tracks, these entries are disabled! See section [3.1.1](#) for more info.

Optimize Moves

The moves between working pieces can be optimized. Therefor the order of the objects is changes like with the entries above.

You can display the moves with the Menu Display ▷ Show Moves.

Working Area...

The Working-Area panel appears. Here you can enter the size of the working area. The measuring unit of the size is taken over from the Preferences-Panel.

The working area is displayed as white background inside the Graphic-Window. If you open a new window, the working area is preset to the size of the machine.

3.2.3 The Tool-Menu

The tool menu gives access to the different tool-panels of Cenon. Some items appear only if the respective module is installed.



- | | |
|---------------------|---|
| Batch Production... | The Batch-Production Panel appears. Here you can distribute the graphic on the working area. The batch production is already explained in detail in the Cenon Reference Guide. |
| CAM-Panel... | The CAM-Panel of the optional CAM module appears. The CAM-Panel is opened automatically after you have started the program. It is used for the management of the layers and tools and to control the machine. See section 3.3 . |
| Teach-In Panel... | <p>The Teach-In panel of the optional CAM module allows the collection of positions from a machine. You can position a plotter or machine over a template using the Control-Panel (section 3.3.3). The positions then can be captured into the document as a mark via mouse click in the Teach-In Panel.</p> <p>The collected mark objects can be converted to 2-D or 3-D lines from within the Teach-In Panel.</p> |

3.2.4 The Display-Menu

The items of this menu hardly depend on the loaded modules.



Show Directions

Here you can see the direction of the vectors displayed as little arrows on the border of the graphic objects. The output usually follows the direction of the arrows. Since, the quality of output depends heavily on the direction of the processing, you should have an eye upon this.

Show Moves

This menu item displays the moves of the machine between different working pieces. The moves are displayed as blue lines.

Show Tool Diameter

The tool diameter used for output is displayed in thickness of the output path. Usually the output path is displayed with thin lines.



3.3 The CAM-Panel

The CAM-Panel offers almost all management functions for CAM. With the different areas the panel offers, you can manage layers, tools, positions, and you can control the CNC machine.

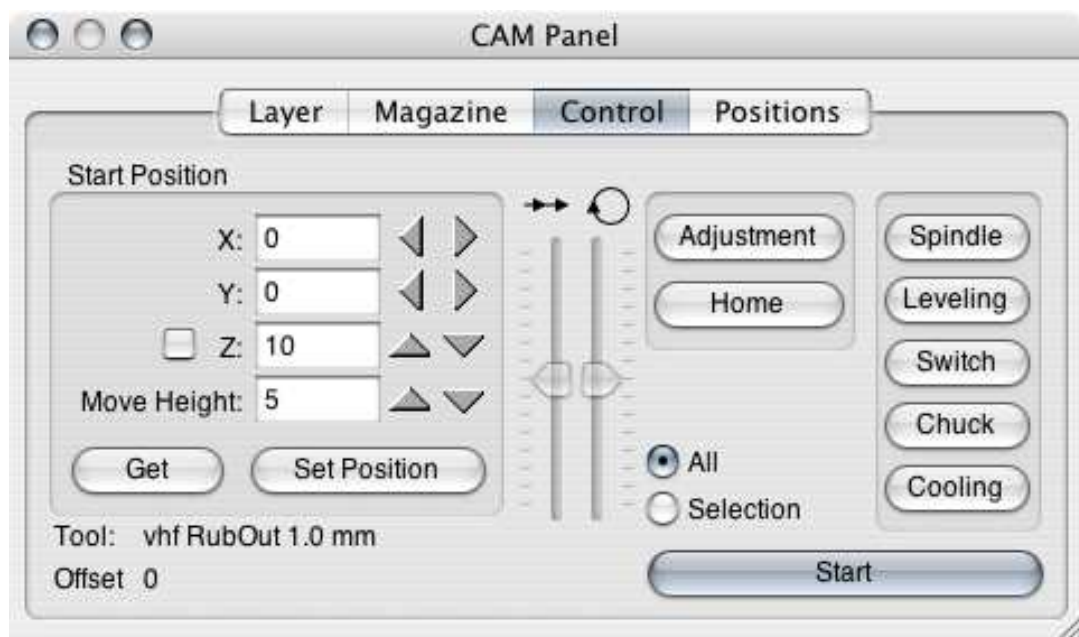

In this bar you can choose the functions of the CAM-Panel like in an index-card-box. Depending on your choice the look and the setting possibilities of the panel change.

You have got the following possibilities:

- managing of the layers (see section [3.3.1](#))
- setting of further details to the layers (see section [3.3.1](#))
- managing of the tool-magazine (see section [3.3.2](#))
- setting of the tool-parameter (see section [3.3.2](#))

- control of the output and the machine (see section 3.3.3)
- management of the position memory (see section 3.3.4)

3.3.1 Layers



The Layer-Panel is for the management of the different layers. The layers are used by Cenon to separate the single steps (e.g. engraving and milling).



Here you can choose whether you want to show the original graphic (tick next to graphic) or the moving range of the tool (tick next to output) in the graphic window. When the output is turned on a new calculation of the output path is started whenever you change the parameter. To be able to work without any difficulties we recommend to switch off the output while editing.

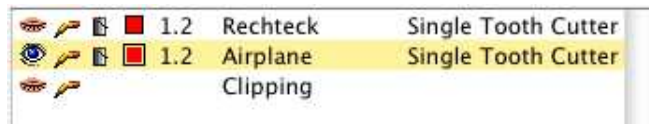

This area is the heart of the Layer-Panel. Here you can already carry out most of the settings for the layers with the small icons.

With the eyes you can switch on and off the display and/or the output of the layer. A layer with closed/shut eyes is not displayed and output/given out. You can use the little pencil to switch on/off the possibility to edit the layer.

A layer with a broken pencil can not be edited and is therefore protected against unintentional/unintended transformations/changes.

Here you can choose whether the elements of the present layer are to be filled or not during the calculation of the moving/driving/drive way. A bucket that is

poured out indicates that an element is filled so that the appropriate area is emptied later during the engraving.

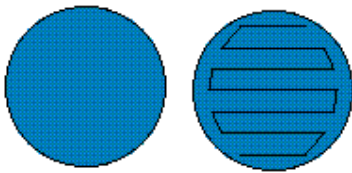

In the right image the element is filled. The output path is calculated for a given tool diameter.

■ ■ ■ Here you can select the kind of tool-radius-correction. You can choose between the outward correction, inward correction and no correction and Pick-Out. When you choose Pick-Out a new layer will be created for the filling.

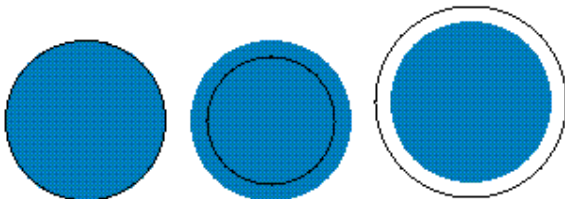

On the left you can see a graphic that has been corrected outwards (miller-radius). This operation is necessary when you intend/want to mill the graphic in its original size out of the basic material. In the middle you can see an example for an inward correction of the miller-radius. This operation is necessary when you want to engrave the graphic into the basic material. No miller-radius correction is carried out in the picture on the right. In that case the T would be reduced by its outer contour/outline by the radius of the used tool during the operation.

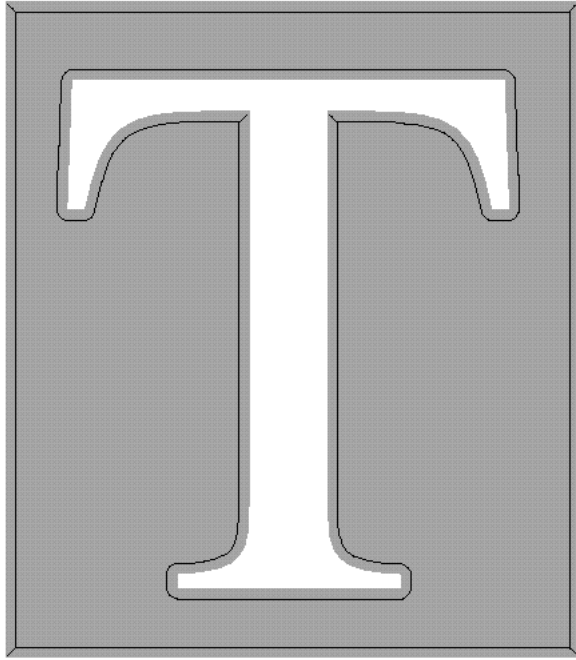

This is an example for the pick-out. You can only carry out the sharpening with a conic tool. The sharpening is mainly an inward correction. But the tool is also lifted appropriately in the edges and when the way is too small for the top/maximum radius of the tool to make the picture as perfect as possible. This function is used e.g. to create hobs. It's very important to use the right tool when you sharpen to achieve a perfect result.

Pick-Out: Further details you can find in section [2.3](#).

To get a tool-radius-correction that is as precise and correct as possible mind the following:

- Use only curves that are not too complicated. When the curves are too extreme the generating of the contour gets more and more inaccurate.

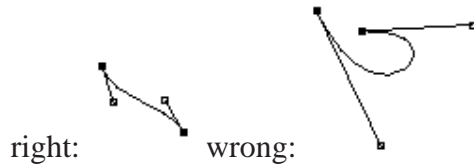

- A path should not have any gaps between its single elements.
- You should use not too many elements to create a graphic because the outline algorithm works faster and better then.
- When the tool for the calculation is too big the outline of the graphic is calculated wrongly in most cases.

Error messages that appear during the calculation of the drive way are displayed in the console window of the workspace-manager.

0.12

This area shows the dip depth of the selected tools in this layer. The dip depth is the distance that the z-axis from the scratch-height dips into the material (you can set this in the machine Control-Panel (see section 3.3.3). The measuring unit is taken over from the Preferences-Panel. Here you can see the name of the layer.

Rechteck

You can enter the name into the edit-field on the right of the window. You get to the panel layer-details with a double-click on this field (see section 3.3.1). You can set further settings for each layer here.

vhf RubOut 1.0 mn

Here you can see the name of the selected tool. The tool can be chosen with the pop-up menu. with a double-click on this field you get to the Tool-Panel (see section 3.3.2) where you can alter the parameters of the actual tool. When you move the name of the layer with the mouse and by pressing the Ctrl-key at the same time you can change the order of the layers in this panel and also the order of the display and output. Cenon gives out the layers in the same order as they appear in the panel.

Therefore we recommend to work on engraving layers first and to cut the outline in the last step.

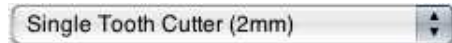

In this pop-up-menu you can set the tool for the selected layer. Here the tools of the magazine that you have chosen in the magazine-panel are shown (see section 3.3.2).

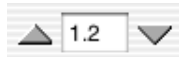

Here you can enter the dip depth. The dip depth is the distance which the z-axis dips into the material from the scratch-height on (you can set this in the machine-control-panel). The measuring unit is taken over from the preliminary settings' panel.



Here you can see and edit the name of the selected layer.

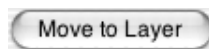

With this button you can move all the selected elements in the graphic window that are on editable layers to the actual/present/current layer. You need this function to separate the single operations.

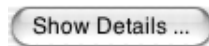

With this button you get into further panels where you can set further details that you don't need very often. (see section 3.3.1).



Here you can create a new layer or delete/erase a selected layer.

3.6.1.1 Layer-details



Here you can enter further settings that you don't need very often for the respective layers.

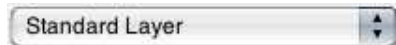

Here you can set the type of the layer. The type is usually 'Standard'. If you need a special layer like a Fitting-Layer or a clipping layer, you can change the type of a layer using this pop-up.



Here you can see and edit the name of the layer. This field has got the same function as the editing-field in the Layer-Panel.



Here you can switch on/off the filling. This button has got the same function as the filling-icon in the Layer-Panel.



Here you can switch on/off the mirroring on output. Usually you will mirror your graphic using the editing functions of Cenon. However, if you want to flip your working piece during output (eg. for production of two layer PCB prototypes), you only want to switch the output, rather the display.

The output will be mirrored by the axis between the two fitting marks on the Fitting-Layer (see section 3.4.2).

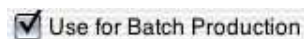

Here you can enter whether the layer should be used for batch production or not. See also the description of the panel for batch production in section ??.

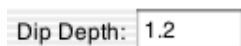

Here you can enter the dip depth of the tool in the basic material. The setting has the same value as in the Layer-Panel.

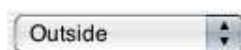

Here you can choose the kind of tool-radius-correction. You can choose between several kinds of correction. The setting-possibilities correspond to the icons in the layer-panel, but extend these for some special types of correction.

Correction	Description
Inside	The tool radius will be corrected to the inside (Engraving)
Outside	Correction to the outside (Cutting)
No side	No correction at all
Pick Out	For detailed engraving (see section 2.3)
PCB Isolation	Special correction of isolation tracks for PCB prototyping
PCB Blow Up	Special correction of Blow Up tracks for PCB prototyping
PCB Rub Out	Special correction of Rub Out for PCB prototyping

Stepwise Z

First Step:

Step Size: #

Final Step:

Cenon supports stepwise working of workpieces. Here you can enter how deep the tool dips into the workpiece during the first operation and how the other operations can be worked on at most and what should be leftover for the final operation. The machine does not dip deeper than the maximum dip depth of the layer. With the switch on the upper left you can switch on/off the stepwise working.

Settlement:

Here you can set a settling for the cutter. During the cutting of the settling only a very small part of the material is removed to smooth the outlines. When the value is not zero the settling is enabled, and the last run around of the cutting process will remove the specified distance for the entire dip depth.

Final Step:

Settlement:

When this switch is turned on the settling is already inserted before the final step of the stepwise operation. This can makes sense because the material might not cope with all the forces of the settling when it is completely cut through.

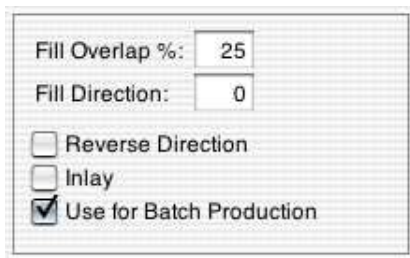

Here are more settings for the selected layer.



Here you can enter the filling-overlapping. The filling tracks are closer to each other by the appropriate percentage when you work with filling-overlapping than when you work without it.



This command changes the direction of rotation of the objects on this layer. With this function you can influence the milling-direction for the output.



If you activate this option, the tool-radius correction is calculated in a different way: Sharp angles are rounded so a outside correction would fit in a inside correction.

A successful calculation using the inlay option demands the right placement of vertices:

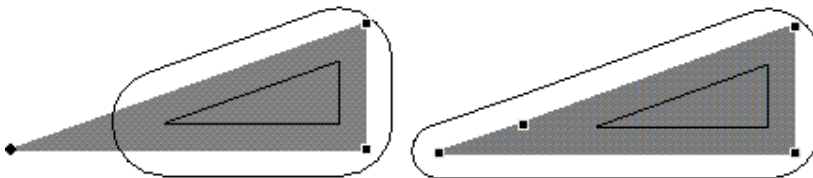

In the left image the vertices are placed right. The angle for the inlay is calculated correctly, and the result of the inner contour will fit inside the outer contour. In the

right image the correction for inlays fails. Always try to avoid vertices close to edges, especially inside the tool radius!

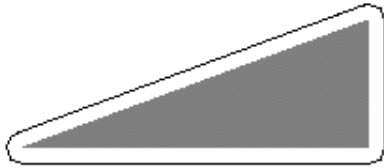

This is a usual tool-radius-correction without the inlay option.

3.3.2 Tool Management



The Magazine-Panel is for the management of the tools. Tools can be distributed on magazines to arrange them for the different operation purposes.

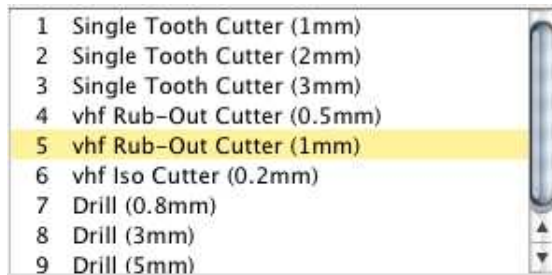

This list shows all the tools of the selected magazine. With a double-click on a tool you reach the window where you can set the tool-parameter of the tool (see section 3.3.2). When you move the tool name with the mouse and press the Ctrl-key at the same time you can change the order of the tools and you can sort the list according to the tool-types and sizes.



In this pop-up-menu you can select the magazine that you want to use for the actual/current/present graphic: The last entry of this pop-up-menu is for the creation of a new (empty) magazine.

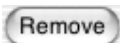

With this button the selected magazine is deleted.

Name:

Here you can enter the name of the magazine.

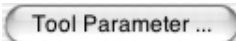

With this button you get to the Tool-Parameters of the selected tools (see section [3.3.2](#)).

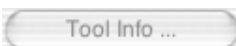

With this button you can reach further tool-information in a later Cenon-version.



A click on this button creates a new tool and changes the appropriate Tool-Parameter (see section [3.3.2](#)).

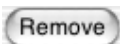

This command deletes the selected tool.

3.6.2.1 Tool-Parameters

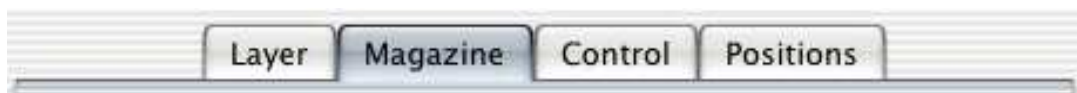

Here you can set the parameters for the single tools.

Name:

In this field you can see and edit the name of the tool.



A tool can be either used as a cutter, a drill, or a thread cutter. A drill can only be moved up and down in the workpiece. A thread cutter is a special tool to cut threads.

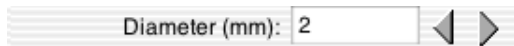

Here you can set the diameter of the tool. Cenon calculates the output tracks with the diameter.

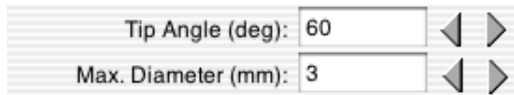

This part is only active for conic tools. Here you can set the tip angle and the maximum diameter of the tool. In this case you have to set the diameter at the tip of the tool for the diameter field.

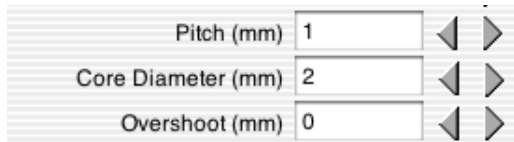

This part is only active for thread cutters. Here you can set the pitch, the core diameter and the overshoot offset.

- Pitch is the pitch of the thread (the distance measured from one tooth to the next).
- the core diameter ($\emptyset C$) is the core diameter of the tool.
- the overshoot offset (lo) is only used for a special kind of thread cutter and is 0 for normal tools.

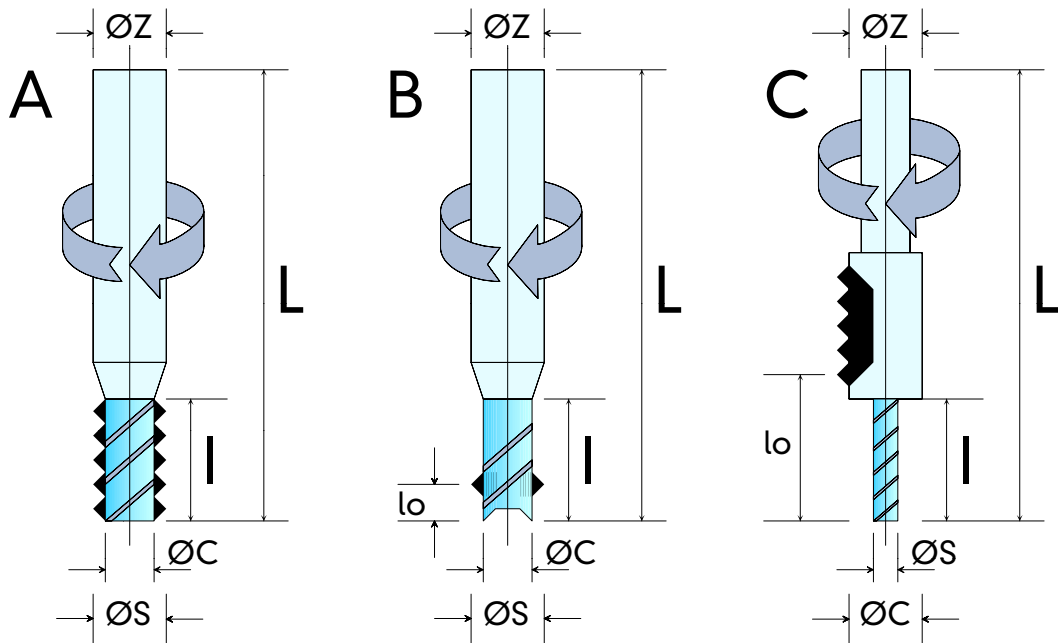

- A Standard Thread Cutter.
- B Drill Thread Cutter (DTC). The special cutter is able to cut the hole and the thread at once. The overshoot (l_o) is the distance from the tip of the tool to the cutting teeth.
- For inside threads the cutter moves to the surface of the material, and then lowering down in spirals to the bottom of the thread + overshoot. Finally, the tool is lifted in the center of the thread.
- For Outside threads the cutter approaches from the outside and can't be lifted in the center of the thread. Therefore you have to provide enough room for lifting the tool!
- C Combi Thread Cutter (Combi or DTC1). This type is used for inside threads only. The tool diameter ($\varnothing S$) is the diameter of the inserted tool plus the depth of the teeth! The core diameter ($\varnothing C$) is the diameter of the

thread section without teeth. The overshoot (l_o) is the distance between the tip of the cutter and the thread section.

$\varnothing S$	Tool Diameter
$\varnothing C$	Core Diameter
l_o	Overshoot (Type B and C)

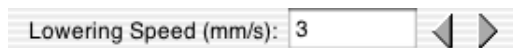

Here you can set the lowering speed of the tool. The lowering speed is the speed with which the tool dips into the material.



Here you can set the cutting speed of the tool. The cutting speed is the speed with which the tool is moved in(to) the material.

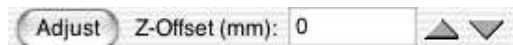

Here you can set an offset for the z-height. This offset levels out tools that have not the same length when you use tools with stopping ring. The proceeding is: first you set the z-position in the Control-Panel for the longest tool. Then you can set the Z-Offset for the shorter tools. When you press the adjustment-button the machine follows your input, and allows for exact adjustment of the offset. When you switch off the adjustment-button the machine moves back to the initial z-position. The offset is saved then for the tool and during the operation this tool is lowered with the Z-Offset added.

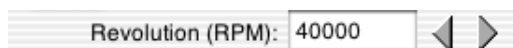

Here you can set the number of revolutions of the spindle. When you have got a powerful controller the number of revolutions is set automatically. Otherwise the value can help you to remember which number of revolutions you have to set manually.



If your machine has an automatic tool exchange, you can select and deselect a tool here. Even if you don't have an automatic tool selection you should use this button to let Cenon know which z-offset and revolution it has to use for your adjustments.

3.6.2.2 The CAM-Panel for the Tool-Information

The tool-information gives you an explanation about the tools. There you can find the text-editor where you can enter information (not implemented yet).

3.3.3 Machine-Control

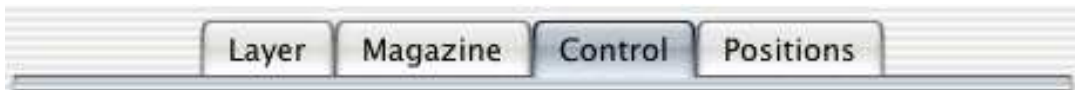

Here you can position the machine. You can also start and stop the output with this panel.

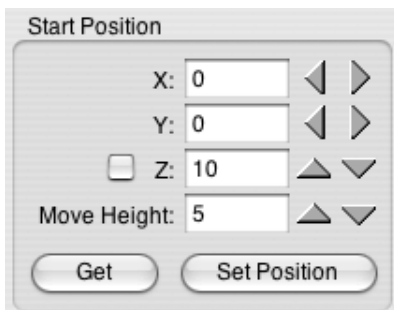

In this field you can set the starting position.

Using the buttons, the machine moves in 0.1 mm steps. If you keep the Ctrl-key pressed while moving the machine, the machine moves in 1.0 mm steps.

If you change the x or y positions, the z axis is always lifted to move height for security reasons!

The setting of the x- and y-position you can also carry out with the cursor-keys on the numeric part of the keyboard (as long as no text is edited).

- Arrow up (8): moves the y-axis in positive direction
- Arrow down (2): moves the y-axis in negative direction
- Arrow right (6): moves the x-axis in positive direction
- Arrow left (4): moves the x-axis in negative direction

Note: If you control the machine via the arrow keys, the machine may happen to move a little longer than you pressed the key! Please take this into account.



Here you can set the position of the z-axis. The z position is the surface of your material. The button for lowering the Z axis has a little magic in it: If you click it the first time, the Z position is set. The next clicks will lower the Z axis.

This setting you can also carry out with the cursor-keys (as long as no text is edited):

- Arrow up (9) lift the z-axis
- Arrow down (3) lower the z-axis

If you activate the switch (lefthand of the Z field), you can adjust the Z-position. This means that you can move X and Y to a position of your choice, and there set the Z-position. If you turn off the switch, the X- and Y-axis return to their initial positions.

If you use an measurement sensor, you can start the measurement by clicking on the down button.



Here you can set the move height (or flight level). This is the distance the tool stays above the surface when positioning. This height is not very critical. However you must ensure that the tool moves height enough to get over all obstacales.



With the button "Set Position" you can move the machine back to the start position, for example after a Home drive or after finishing the output.

"Get Position" asks the CNC controller for its position. This is only available, if your CNC controller supports this feature. The button enables you to set the starting position more comfortable with a hardware control panel. When pressing the get button, the machine position will be taken into Cenon as the start position. For Z this is the surface position on your working piece. (Also take a look at the configuration entry #GPA in Section 4.2)



The two sliders allow the relative changing of the feed and spindle revolution during the output. The parameters are altered from about 20 to 200% of the values entered for the tool.

The sliders are available only, if your CNC controller supports this feature. (Also see the configuration entries #AVS and #ARV in Section 4.2).



Here you can carry out an adjustment drive or a zero drive. An adjustment drive justifies the machine and moves it back to the start position. A zero drive (Home) moves the machine back to zero and remains there.



Here you can choose whether all layers that are displayed with an open eye should be given out (that means all the layers) or only the selected elements in the graphic window (selection).



This button starts the output. You get to the window that asks you to chuck in the first tool when you don't have an automatic tool change. During the operation the button changes its look - it becomes a stop button. With this button you can end the operation if you want. Please mind that the machine processes a few more vectors before it stops. **In case of emergency press the emergency-stop-button of the machine!**

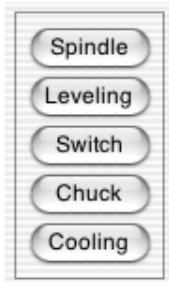

Here you can control some of the technical equipment manually if your controller has got the appropriate in/out ports.

3.3.4 The Positioning Memory



Here you can set the starting positions of the machine for different purposes.



With this pop-up-menu you can choose the starting position. With the last entry, new position, you can create a new position. The current starting position is taken from the Control-Panel as the value of the new position.

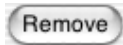

Here you can delete the selected position-entry.

Name:

Here you can enter the name of the position-entry. We recommend to name the position memory after the material that is worked there.

X:	<input type="text" value="7"/>	◀	▶
Y:	<input type="text" value="240"/>	◀	▶
Z:	<input type="text" value="60"/>	▲	▼
Move Height:	<input type="text" value="2"/>	▲	▼

With these buttons you can set the starting position in the same way as in the Control-Panel.

add Marker Positions

With this switch active, all the drill markings from the current document will be added to the position list. Only markers with name are added to the list. When positioning to a marker position, the move height is not set.



The machine moves to the entered position and switches to the Control-Panel.

3.4 Layers

Additionally to normal layers, Cenon provides some special layers, which will be described here. This special layers are for example the Clipping Layer (see section [3.4.1](#)) and the Levelling Layer (section [3.4.3](#))

3.4.1 The Clipping-Lage

The clipping layer is a special layer used to clip objects on other layers for output. It can be used for long sign which don't fit on the machine table, and thus can't be processed at once. This process is also known as panelling.

You can change a layer into a clipping layer by setting the layer type in the layer details (see section [3.3.1](#)).

Long signs can be divided in two groups:

1. Signs which can be produced in two parts, and are assembled later (example 1). Here you just can run two separate jobs
2. Signs where the working piece can't be devided (e.g. a handwriting). In this case the entire sign is divided into areas which are processed one after the other (example 2).

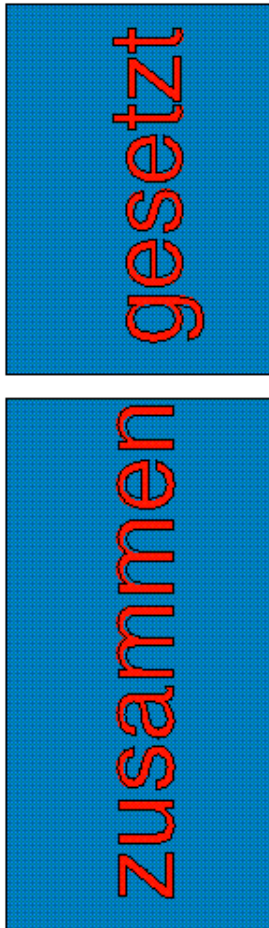

Example 1

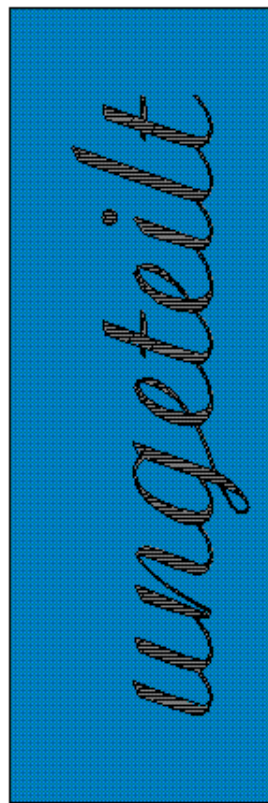

Example 2

Before you start, you should prepare a guide on one side of your machine. This way you can move the working piece along the guide without worrying about the positioning in this direction. By using markings you can even get highest precision for moving the working piece.

1. Place the material on the machine table.
2. Load the file with the complete sign (see example 2).

3. Prepare all necessary steps for cutting (tools, radius-correction, parameter etc.), and calculate the output tracks
4. Now, the first part of the sign can be activated. To do this create a rectangle on the Clipping-Layer. Use the Rectangle-Inspector to set the exact dimensions of the rectangle.

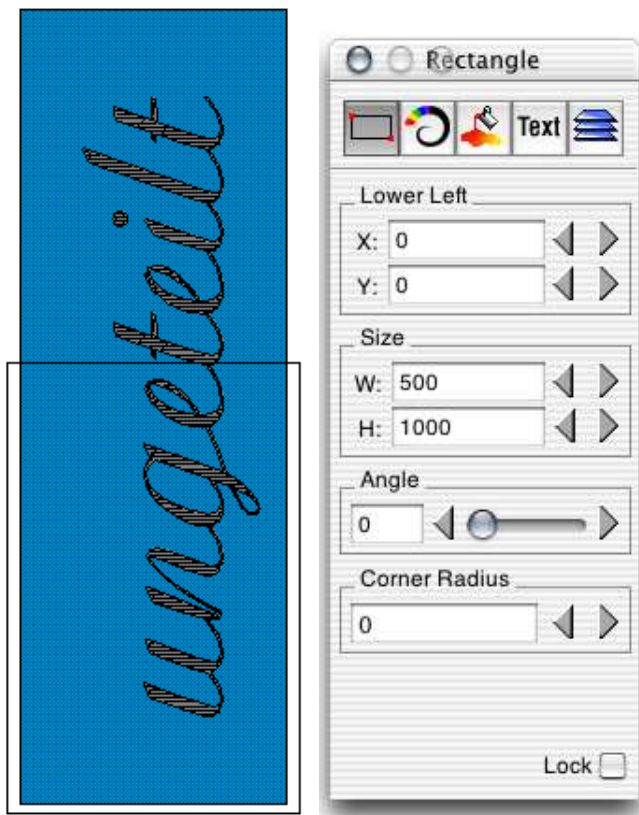

In this example the first area includes approximately half of the sign. Be sure to place the rectangle for clipping on the clipping layer. In the Rectangle-Inspector the size and position are displayed. Position the crosshairs to the same position as the rectangle.

5. Now, move the machine to the lower left corner of the material and adjust the

tool. Then you can start the output of the first part.

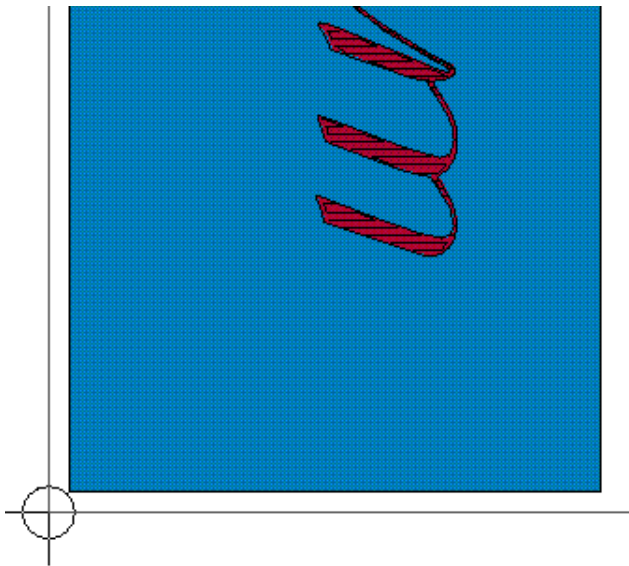

6. Now you can define the second part of the sign: Therefore move the rectangle on the Clipping-Layer to its new Y position using the Rectangle-Inspector. For our example we get the following:

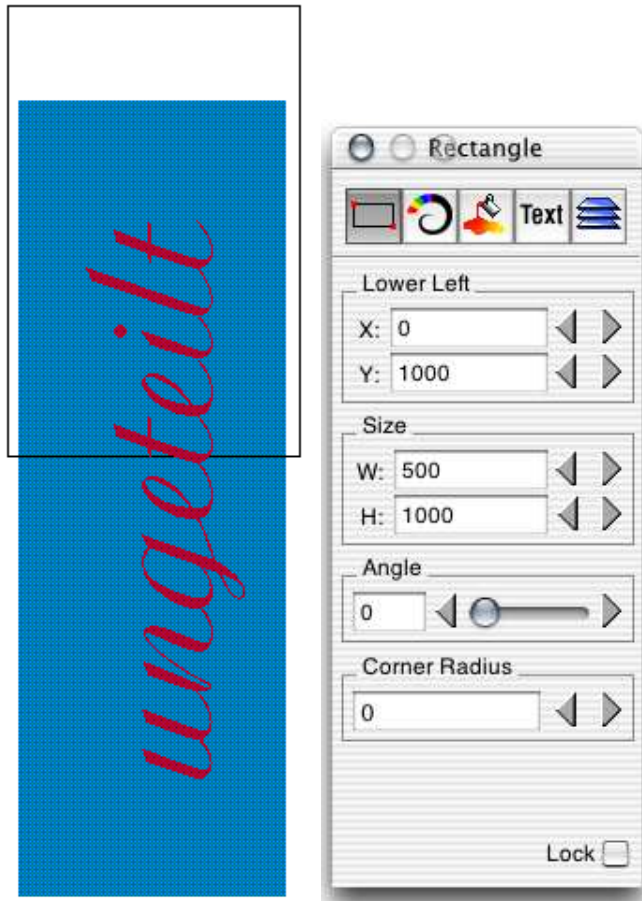

As you can see, we moved the rectangle from the position $Y = 0$ to $Y = 1000$.

7. Now we move the crosshairs the same distance in the same direction:

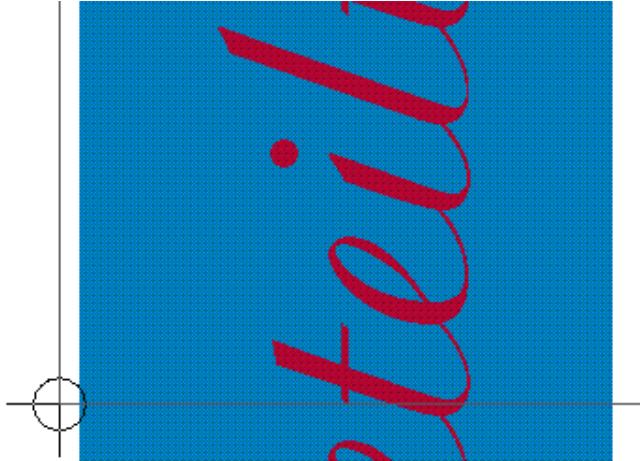

At third we have to move the material the same distance in the same direction. If you need highest precision use markings.

8. Now start the output.
9. Repeat the steps 6 to 8 until the complete sign is finished. Keep in mind, that you have to move the clipping rectangle, the crosshairs, and the material. They all have to be moved the same distance and the in the same direction.

Note: The crosshairs are your zero point as well as the start point of your machine. So, the rectangle inspector displays the position relative to the crosshairs, and on the other side, the Crosshairs-Inspector displays the coordinates of the crosshairs measured from the zero point of your window.

3.4.2 The Fitting Layer

The Fitting Layer is used to place exactly two fitting marks. They are used, if you have to process a working piece from both sides.

To achieve this goal, the output can be mirrored by the axis between the two fitting marks. Select the switch 'Mirror' in the Layer-Details (see section 3.3.1) to activate the mirroring for a layer.

You create a Fitting-Layer by creating a normal layer ('New' inside the Layer-Panel), and afterwards changing the type of the layer to 'Fitting bolts' (Layer-Details panel).

The use a fitting bolts is rather straight:

1. Create a fitting layer and place the two marks in a way that allows you to flip your working piece by the axis between the two marks.
2. For all layers which shall be mirrored after flipping the working piece, activate the switch 'Mirror' in the Layer-Details.
3. Start output by drilling the holes for the fitting bolts, so that you can fix your working piece with two bolts.
4. Continue the usual output of the first side.
5. Now, flip your working piece, and process the mirrored layers.

You can find some examples using fitting bolts in the distribution of Cenon.

3.4.3 The Levelling Layer

The Levelling Layer appears if your CNC controller supports the surface measuring of working pieces. This is the case for the CNC 750 from vhf.

In this case you can create a rectangle on this layer, which defines the area of measurement.

In the Layer-Details (see section 3.3.1) of the Levelling layer, you can provide the number of test points for the x- and y direction. The created rectangle will be measured using the given number of test points for each direction.

If you want the surface of your working piece measured, be sure to display the levelling layer, before starting the output. The Levelling layer is processed first, before other layers are processed.

If you have measured the surface once, the surface usually remains measured until you switch off the CNC controller (this can vary in different configurations).

3.5 Barcode Import

This special feature allows the import of files via a code, which is entered into the following panel. The code can also be entered using a bar code reader. Application of this function is in large series production. The required lists of codes can be generated by a spread sheet or a database program.

If the feature is activated, the panel can be reached through the menu "Document > Open Barcode...".



To use this function, a configuration file must be placed into the library folder (See Section 5.2) of the user. The configuration file describes the format of the list of codes and filenames. The filename of the configuration must be "barcode.plist".

Example of a "barcode.plist":

```
/* This file configures the loading of files via bar codes entered
```

```

* into the Barcode Panel of Cenon.
*
* All paths are relative to "Library/Cenon/CAM" or absolute "/...".
*
* If the name (2nd entry) from the list file (listPath) is relative,
* an optional folder name (3rd entry) may be added.
*
* examples of formats ('listForm'):
* " 57975;00006427.dwg;00006" -> "%5s;%12s;%5s"
* " 57975;00006427.dwg;00006" -> "%[0-9];%[^;];%[0-9]"
* "123456 fileName folder"    -> "%s %s %s"
*/
{
    enabled = 1;                // 1 = enabled, 0 = off
    listPath = "zeichnvz.txt";  // HOME/Library/Cenon/CAM
    //listForm = "%s %s %s";    // identifier, file name, [folder name]
    listForm = "%[^;];%[^;];%s"; // identifier, file name, [folder name]
    filePath = "";             // HOME/Library/Cenon/CAM
    setMarker = 1;            // 1 = set marker at UR position
    layerName = "Bounds";     // name of layer for marker
}

```

Description of the Entries:

- enabled** is this entry = 1, the function is activated and the Menu item appears.
- listPath** Here, the name and path of a list, containing the mapping of codes and file names, is defined. If only a name is given, the library path is assumed.
- listForm** This entry defines the format of the list. Each line must be in the order code, file name, and an optional folder name.
- %s is a wildcard for any characters
- %[^;] is a wildcard for any character up to a semicolon
- %5s is a wildcard for a string of exactly 5 characters
- %[0-9] is a wildcard for the characters 0 - 9

- `filePath` This entry defines the path of the imported files. If empty, the library path is used.
- `setMarker` If this entry is = 1, a marker is placed at the position of the bounding rectangle of the imported graphics. This marking will get a name and may be used inside the position memory (See Section 3.3.4). The marker is played on its own layer.
- `layerName` The name of the layer, which will be added for the marker.

The Syntax of the configuration file:

The syntax of the configuration is the same as used for most other configuration files in Cenon. Each entry is a relation of the form `KEY = VALUE;` An entry must be terminated with a semicolon.

- `{...}` encloses the contents of the entire file
- `/*...*/` encloses a comment
- `//` starts a comment up to the end of line
- `KEY = VALUE;` an entry

The mapping file:

The list for the above configuration may look like this:

```
" 57975;file001.dxf;folder1"  
" 57976;file002.dxf;folder2"  
" 57977;file003.dxf;folder2"
```

Chapter 4

Device Configuration

4.1 General Information

The configuration files of Cenon are ASCII files containing all the information needed for the definition of devices and import formats.

This section will describe how to configure Cenon for the different "dialects" of Gerber, HPGL as well as for your own XYZ-units and controller. Although Cenon comes with a number of predefined configuration files (*.dev), there is a chance that the commands of one or the other program is not understood properly or that there is no 100% matching configuration file available for your controller or device. Unfortunately, there are slight differences in the command set of the different programs and controllers.

4.1.1 Creating your own configuration files

In case you do not find a suitable configuration file for your purpose in one of the device directories (HPGL, DXF, xyz etc.), you can alter an existing file.

- Start a text editor.

- Load an already existing configuration file (extension: *.dev). Only load files from the appropriate directory and save them in the same directory after modification. This is very important, because Cenon uses the directory name for accessing the right file format. The setup directory names, for these reasons, should not be changed. Therefore, a Gerber configuration file should only be placed in the directory Gerber, etc.
- To avoid duplication of work you should load a configuration file which matches the command set of your computer the most. You can change the configuration file to your needs using the information provided in the output device manual.
- After changing all necessary entries you have to save the file (to the same directory under a new name) and quit the text editor.
- Load from within Cenon the newly created file (Menu: Info▷Preferences) and you are ready to start.

4.1.2 Important Notes

- The comments before the number sign (here: controller) are not important for the program (comment here: device name). These can be changed to your needs or even deleted. Cenon is recognizing only the characters from the number sign to the end of the line (here: "CNC750"). Example:

```
controller                #CNC "CNC750"
```

- The entries are not permitted to exceed more than one line.
- The order of the entries is not important, unless there are several entries with the same #-code. You also can delete an entry if it is not necessary.
- Within a command line you can add after a backslash () certain sequences to the code. You could for example, write in a new line each single command in the output file:

<code>\n</code>	Neue Zeile (Zeilenvorschub)
<code>\e</code>	Escape-Sequenz
<code>\r</code>	Carriage Return (Wagenrücklauf)
<code>\"</code>	Anführungszeichen

- If you have to leave space for variable parameters, which will be provided by Cenon. This is done with a percent sign (%) followed by a letter:

`%f` will accept a floating value (with decimal values entries). The output format can be regulated with these entries. Examples:

`%.0f` -> 1

`%.2f` -> 1.00

`%2.2f` -> 01.00

`%2f` -> 01

`%d` is describing decimal integers

`%x` is describing hexadecimal values

`%ld` is describing decimal long integers

`%e` is describing numbers with exponents

- Transmitted commands are always in quoted and also contain the appropriate variable (e.g. pen selection for a HPGL-Plotter:

```
select pen                #PEN "SP%d;"
```

- Parameter providing information to Cenon (e.g. number of pens for HPGL-plotter or the size of the working area) are not quoted:

```
number of pens           #NPN 8
```

- If several values are passed on to the program in one command line, these values have to be separated by at least one space (e.g. maximum working area of a unit):

```
X Y Z-maximum range (mm) #SIZ 380 235 63
```

4.2 Output Devices (CNC controller)

4.2.1 General Information

Almost all CNC-controllers are different in their command set and almost each single output device has different scaling or resolution. For Cenon to address your configuration properly, you should check the configuration file before you first use your output device. As mentioned earlier, you can find this configuration file in the folder `Devices/xyz`. The files have the extension `*.dev`. You can edit these files, make your changes accordingly and save the file. The name of the `*.dev` file will then appear in the appropriate pop up in the Cenon Preferences-Panel.

In the following section, we will explain how to change certain parameters to suit your specific device. These parameters are needed to drive the CNC-controller. If you do not know the parameters for your device, please refer to the device manual or determine the correct values by carefully measuring and testing. Many of these command set are similar to HPGL command sets.

4.2.2 Commands in the configuration file

```
description #DES
```

Enter in this line the name of your device or of the controller used. This line has only explanatory value.

```
controller #CNC
```

Here you have to enter which controller principle your device is using. You have the following choices:

```
"HPGL"      HPGL compatible devices
```

```
"DIN"       DIN 66025 compatible devices
```

"CNC450"	using extensions for vhf controller CNC 450
"CNC750"	using extensions for vhf controller CNC 750
"CNC550"	
"CNC950"	
"CNC1050"	using extensions of the vhf CNC 550, 950, 1050 controller series
"ISEL"	support for the ISEL command set
"MCM"	support for the MCM command set

spindle lift time (ms) #TIM

Time in milliseconds needed to lower or lift from the working part. This is only necessary for devices with a switching axis.

origin (0=lower/left 1=upper/left) #ORI

You can enter here if the origin of the output device is located in the upper left corner (for XYZ devices) or in the lower left corner (for plotters). If for any reason this entry is missing, it is automatically assumed that the origin should be located in the upper left corner.

look ahead #AHE

Number of commands (not characters) which are send to the device before checking the return values.

terminator (for removal of return values) #TRM

Separator between commands. It is used to keep track of the number of commands send to the device. Example: ";"

```
comments ('*' = wildcard) #REM
```

This entry may be used to remove remarks from large initialization sequences (#INI, #INI1). The entry must start with the starting character(s) of the comment, followed by an asterisk (*) and the terminating character of the comment, usually a line feed (\n).

Example for CNC 550: `"/*\n"`

```
debug level (0=off) #BUG
```

To test the connection and processing of a new controller, you can activate the debug output. If you set a value other than 0, the machine initialization, outgoing commands and return values are logged to the console window.

```
baud rate #BAU
```

If your controller is connected to the serial port you have to enter the baud rate. This rate indicates the speed of data transfer between computer and output device. For most controllers you can choose 19.200 baud. These rates have to be set at the controller as well.

```
parameter (0=8N1, 1=7E1) #PAR
```

Set the transmitting values for the serial port here. Enter a 0 for 8N1 (8 data bits, no parity, 1 stop bit) or a 1 for 7E1 (7 data bits, even parity, 1 stop bit).

```
device #DEV
```

The Unix device used for output. Example: `"/dev/ttyS0"`

```
X Y Z-maximum range (mm) #SIZ
```

You should enter here the unit of measurement for your controller in points per inch for all three axes. If you use a switching axis for z, insert the same value than for x and y.

```
X Y Z-resolution controller (points/inch) #RES
```

This entry holds the resolution of your CNC controller for all three axis in points per inch. If you use a switching axis for Z, set the value for Z equal to X or Y.

```
X Y Z-resolution of mechanics (steps/mm) #SCL
```

These values describe the mechanical resolution of your device for all three axes. It indicates how many steps are necessary to cover one millimeter. Calculated example for the device CAM 100:

```
[steps/rotation] / [pitch of spindle]
= [steps/rot] / [mm/rot] = [steps/mm]
= 400 / 5 = 80
```

this entry would look like this: #SCL 80 80 80

```
Flatness #FLT
```

Enter here a precision factor with which bezier curves (and arcs) will be divided for the output device. If this value is large the curve appears very coarse. In case a value is missing a default value is assumed. If this entry is missing, the default(0.15) is used.

```
Maximum length of line #MLN
```

Some CNC controllers don't provide a command to stop the output process. If you would stop the output, the machine would continue to draw the last command completely before stopping. If this was a long line you have to wait quite a time before the machine finally stops. To set the maximum length of line to a reasonable value (eg. 5 mm) will allow you to stop the output immediately. Additionally, some CNC controllers move smoother with shorter line segments.

X Y Z Positioning Offset (cartesian) [mm] #POF

If you have attached a camera to your machine for more exact interactive positioning, you can enter the distance here the camera has to the tool. If you adjust the position using the Control-Panel of Cenon, the offset is added to the real position. For normal applications this offset is zero for all axes.

XY-minimum speed for draw (steps/s) #XMI

This entry describes the minimum working speed in steps per second the device can use to complete the job (engraving or routing mode). The working speed entered here and the following entries describe the minima and maxima for the speed. The actual used speed can be entered from the depot window where you have access to the different tools available or configure new tools.

XY-maximum speed for draw (steps/s) #XMA

Maximum working speed in steps per second.

Z-minimum speed for draw (steps/s) #ZMI

Minimum speed for lowering the tool onto the working part.

Z-maximum speed for draw (steps/s) #ZMA

Z-maximum speed for the z-axis while lowering the tool into the working part.

XY-speed for move (steps/s) #XPV

Speed for positioning the tool on the move height (flight level).

Z-speed for move (steps/s) #ZPV

Speed to adjust the positioning of the tool in z-direction above the working part.

initialize #INI
initialize 1 #IN1

To configure your output device to your needs, all data to initialize the unit (e.g. steps per rotation, etc.) have to be available first, even before any data of the actual task will be passed on. You can insert any necessary command to initialize your device. IN1 is send directly after INI, so you can split your initialization into two parts.

adjustment drive #REF

Code to start the adjustment drive. Example: "!N;RF;"

return value for ok #RET

Any action performed flawless by the CNC controller is prompted by sending a reply to Cenon. This reply can be entered here as a decimal value for most controllers. The vhf CNC controllers of the 550, 950, 1050 series, return several characters as reply. In this case two strings are expected here: first the entire reply string, second the initials of optional error codes.

If you don't enter a value here, no return values are checked.

Example for a return value of '0': #RET 48

Example for the CNC 550: #RET "0;" "E"

separate thread for return values (1=Yes) #THR

If you activate an extra thread, then the return values during output are collected asynchronous by a separate thread. This improves the output performance.

This option can only be used with controllers, which support the wait command (#WAI) like the CNC550 and CNC950. The option Look Ahead (#AHE) is ignored, if you activate the thread.

```
wait until all data is processed          #WAI
```

The command is send after sending all data to the controller to wait until the controller has finished operation. Cenon waits until the controller sends a '!' to signal that all data has been processed.

Example: "!H1;"

```
delay                                     #DEL
```

Delay command to wait until the spindle achieved its revolution. The time value #TIM can be used here by providing a variable (%d).

Example: "D%d;"

```
set speed draw (v)                       #VDR
set speed move (v)                       #VMV
```

Commands to set the working speed (speed inside the working part) and the positioning speed (move). The commands can be different for draw and move. If #VMV is missing the entry of #VDR is used. If you are using special move commands (#G1D, #G2D, #G3D), no move speed is needed.

Example: "VS%.0f;"

```
move absolute (x,y,z)                    #G3D
```

Command to move in x, y, and z direction. No speed is set, before issuing this command. If this command is missing, Cenon will interpolate it with #MOV and #MVZ.

Example: "GA%.0f,%.0f,%.0f;"

```
move absolute (x,y)                      #G2D
```

Command to move in x and y direction. No speed is set before issuing this command. If the command is missing, the corresponding draw/move command is used (#MOV). Example: "GA%0.f,%0.f;"

```
move absolute (z) #G1D
```

Command to move in the z-direction. No speed is set before issuing this command. If the command is missing, the corresponding draw/move command is used (#MVZ). Example: "GA,,%0.f;"

```
draw/move absolute (x,y,z) #M3D
```

Command to move in x, y, and z direction. If this command is missing, Cenon will interpolate it with #MOV and #MVZ. The speed will be set before issuing this command.

Example: "A3%.0f,%.0f,%.0f;"

```
draw/move absolute (x,y) #MOV
```

Command to move in x and y direction. The speed will be set before issuing this command.

Example: "PA%0.f,%0.f;"

```
draw/move absolute (z) #MVZ
```

Command to move in the z-direction. The speed will be set before issuing this command.

Example: "ZA%0.f;"

```
arc (x-center,y-center,angle) #ARC
```

Code to draw a circle segment (arc) in the HPGL style. If all arc commands are missing Cenon will interpolate arcs. The flatness entry (#FLT) is also used to interpolate arcs.

Example: "AA%0.f,%0.f,%0.f;"

```
arc cw (x-ctr,y-ctr,beg-angle,end-angle) #G02
arc ccw (x-ctr,y-ctr,beg-angle,end-angle) #G03
arc cw (radius,beg-angle,end-angle) #G02
arc ccw (radius,beg-angle,end-angle) #G03
```

Code to draw an arc in the DIN style. The DIN language needs two arc commands, one for clockwise and one for counter clockwise arcs. Additionally, there are two ways to use the commands with two different sets of parameters. Which one will be taken is decided upon the number of parameters.

```
curve (x2,y2,x3,y3,x4,y4) #CRV
curve (x2,y2,z2,x3,y3,z3,x4,y4,z4) #CV3
```

Code to draw a 2 or 3 dimensional curve. If this command is missing, Cenon will interpolate the curves. In this case the value given for the flatness (#FLT) is used.

```
helix (x-cener, y-center, angle, z) #HEL
```

Code to draw a helix. If this command is missing, Cenon will interpolate the helix using arcs or lines.

```
tool up #TUP
tool down #TDN
```

If you are using a switch-axis with lift magnet instead of a freely positionable z-axis, you can enter the code for lifting and lowering here.

Example: "PU;"

```
select tool (n) #TOL
```

If you have an automatic tool selection, insert the command to change the tool here. If this command is missing, Cenon will ask you to change the tool.

Example: "SP%d,1;"

```
set spindle (rev/min) #REV
spindle off #RV0
spindle range (min, max) #RVR
```

If you have a spindle which can be automatic driven, insert the commands here. You have to provide a command to switch on the spindle, and set the revolution (#REV). The second command switches off the spindle (#RV0). The third entry (#RVR) tells Cenon the range of revolution the spindle can achieve. If the commands are missing, Cenon will ask you to switch on the spindle. Example:

```
#REV "RVS%d;"
#RV0 "RVS0;"
#RVR 5000 60000
```

```
get position #GPA
```

This entry allows reading the machine position into Cenon. If the entry is available, the corresponding button inside the Control-Panel of Cenon is activated. You can make use of this feature to set the starting position directly at the machine with a hardware control panel.

The reply to this command from the controller is expected in the form "PA=x,y,z,...".

The Z position is used as the surface position.

Example for CNC950:

```
#GPA "?PA;" "PA="
```

Measurement

```

measure surface position          #SFM
get surface position (CNC750)    #SFG
sensor height [mm]              #SFH

```

These commands may be used to determine a tool offset measured relative to the surface of the working piece. This is always used for automatic tool change. The measurement lowers the Z axis until a switch or contact is triggered. The position can either be returned directly (ex. CNC950) or queried in a separate command (ex. CNC950). Also see section 3.3.3. The height of the sensor itself may be provided. It will be simply added to the measured distance. Example:

```

#SFM "WMZ;"
#SFG "?V40;!H0;"
#SFH 10.0

```

Surface Leveling

```

Leveling CNC750 (x, y, nx, ny)    #LEV
Leveling Default (nx, ny, deltaX, deltaY) #LEV
Leveling, keep tool (1 = keep tool) #LEVT 1

```

If your controller provides a command to measure the surface of a given area, you can insert it here. Cenon supports two variants of this command, one for the CNC750 controller and a default one. Examples:

```

Leveling CNC750 #LEV "SH3, %f, %f, %d, %d;"
Leveling CNC950 #LEV "SH2, %d, %d, %f, %f;"

```

Asynchronous Commands

```

halt          #HLT
continue      #CNT
break        #BRK

```

If your controller provides priority commands to stop, continue and break execution, you can insert them here. Examples:

```
#HLT "!S;"
#CNT "!C;"
#BRK "!B;"
```

After canceling the output the synchronisation between Cenon and the CNC controller is lost. To restore synchronisation Cenon proceeds as follows: If a synchronisation command (entry #WAI) is available, it will be send and waited for the return sign '!'. Without a synchronisation command Cenon clears the input stream for 5 seconds.

```
alter speed      (0 - 200%)      #AVS
alter revolution (0 - 200%)      #ARV
```

These entries allow changing the speed and revolution during output. If the entries are available to Cenon, the sliders inside the Control-Panel of Cenon are activated during output. Example for the CNC950 series:

```
#AVS "OVA%d;"
#ARV "ORVA%d;"
```

Tangential knife

The entries #TAN, #TAM and #MVT are used to drive a tangential knife. Cenon controls the rotation of the knife in this case.

```
/*
 * tangential knife
 */
range (mm), res mechanic (points/inch) #TAN 720 352.778
  range = 2 * 360 deg
  res = 5000 pts/U / 360 deg * 25.4
max angle (deg), max vector (mm) #TAM 20.0 1.0
move + rotate tangential knife (x, y, t) #MVT "PA%.0f,%.0f,%.0f;"
```

- #TAN provides the range and resolution of the T-axis. The values can be calculated by the given formula. The example values are the defaults. The values in the example are the defaults.
- #TAM provides the maximum angle to rotate the knife within the material (in degree of arc), and the maximum vector length to rotate the knife while moving the vector (in mm). The values in the example are the defaults. For angles larger the maximum angle, the Z axis is lifted to rotate the knife.
For segments longer than the maximum vector length, the knife is rotated at the end of the vector. This allows a smooth continuous rotation for curves and arcs (small vectors), while long straight lines are cutted without rotating the knife.
- #MVT provides the command to move the T axis.

Attention:

The values indicated in parenthesis () in the comment part on the left, show the parameters your command has to provide, and are later inserted by Cenon. For each parameter listed, the code has to have an identification of the number type (e.g. %f for a floating value; see section [4.1.2](#) for details).

Chapter 5

Appendix

5.1 What you should know about tools

5.1.1 Reasons for more cutting edges ...

The cutting edge is the working part of the tool. The more cutting edges a tool has, the more cutting edges share the tool erosion, thus the life of the tool is longer.

- A cutter which has two or more cutting edges runs more true than a milling cutter with just one cutting edge.
- Due to the larger cross section of the multiple teeth cutter, more heat is transported to the collet chuck. This is especially helpful if there is no other way of cooling.
- The more cutting edges there are, the smaller the chips become, so you will get smoother surfaces. A double tooth cutter is suitable especially for working on very hard synthetic material and harder aluminium types. We recommend triple tooth cutters especially for very hard non-iron metals and iron workpieces

5.1.2 Reasons for few cutting edges...

The main problem that may occur during the milling process is the possibility that chips may choke the tool. If a milling cutter is finally choked, it cannot carry out chips any more and the feeding force of the spindle will break it. This happens - depending on the material - in most cases long before the cutting edges are worn out. So the main question is where to put the chips. "To the to resp. to the back" is usually the answer (except left-hand twist cutters). However, a certain space is necessary to move the chips along the "body" of the cutter. A comparison of the cross section of different types shows clearly that the single tooth cutter offers the largest open space (size of the groove for chips) and that this space is reduced with increasing number of cutting edges. It is easier for a milling cutter with few cutting edges to dip into the material. For working on material which is used mainly for sign making like synthetic material, wood and non-iron metals, the single tooth cutter has certain advantages. The danger that the cutting edges may erode is not as serious as the problem that the cutter may get choked.

5.1.3 Cross Section:

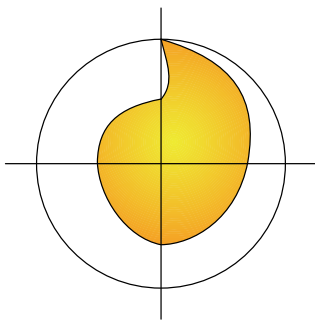

Single tooth cutter (This tool offers a wider open space).

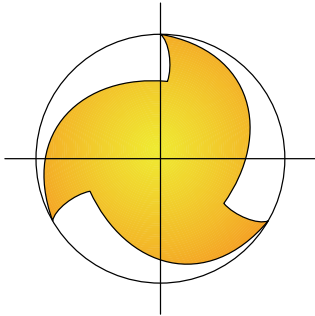

Triple tooth cutter (Three cutting edges need much more space).

5.1.4 Working Parameters

General rules:

1. The higher you set the cutting speed ($v_c = \pi * \text{ØS} * n$), the smoother the surface will be. At the same time the erosion of the tool increases.
2. Recommended cutting speeds v_c for carbide milling cutters:
 - Aluminium: 100 - 300 m/min;
 - other non-iron material (brass, bronze, copper, zinc): 100 - 200 m/min;
 - stainless steel (VA): 80 - 120 m/min;
 - thermoplastic: 50 - 150 m/min;
 - duroplastic with filling material: 100 - 150 m/min;
 - carbon fiber compound material: 150 - 300 m/min.
3. Recommended feed f_z per cutting edge and revolution for carbide milling cutters:
 - Aluminium and other non-iron metals:
ØS 2 - 4 mm: 0.04 mm/U

ØS 5 - 8 mm: 0.05 mm/U
 ØS 9 - 12 mm: 0.10 mm/U

- Thermoplastic:

ØS 2 - 4 mm: 0.05 mm/U
 ØS 5 - 8 mm: 0.06 mm/U
 ØS 9 - 12 mm: 0.07 mm/U

- Duroplastic, GFK:

ØS 2 - 4 mm: 0.04 mm/U
 ØS 5 - 8 mm: 0.08 mm/U
 ØS 9 - 12 mm: 0.10 mm/U

4. Formulas:

revolution n: $n \text{ [rev/min]} = (vc \text{ [m/min]} * 1000) / (3.14 * \text{ØS [mm]})$.

feed f: $f \text{ [mm/min]} = n * fz * z$

Example:

You want to mill aluminum with a double tooth cutter ØS = 3 mm (given above: max. vc = 200 m/min).

max. revolution n:

$$n = (200 * 1000) / (3.14 * 3) = 200.000 / 9.42 = 21230 \text{ rev/min}$$

feed f:

$$f = 21230 * 0.04 * 2 = 1698 \text{ mm/min}$$

5.1.5 Geometry and Dimensions

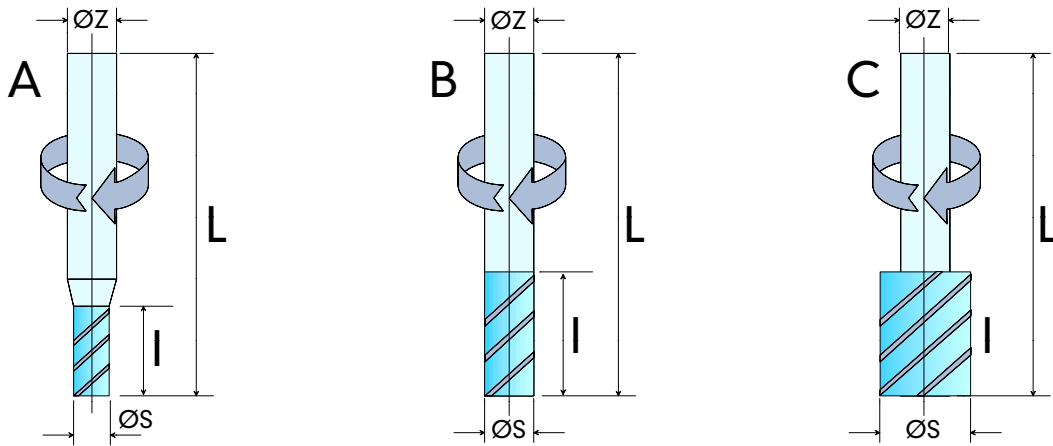

Shape A: diminished cutting diameter $\text{ØS} < \text{ØZ}$.

Shape B: cutting diameter equals shaft diameter $\text{ØS} = \text{ØZ}$

Shape C: extended cutting diameter $\text{ØS} > \text{ØZ}$ (only for drills)

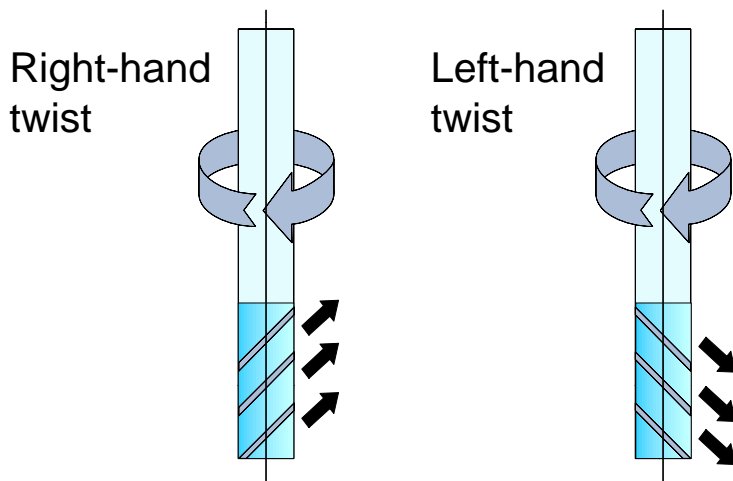

Right-hand twist cutters:

The chips are transported to the top. The milling cutter tends to lift up the workpiece (corkscrew effect).

Left-hand twist cutters (custom shape):

The chips are pushed down, resp. moved to the back, i. e. to the already milled channel. The milling cutter pushes the workpiece down on the table (reversed corkscrew effect).

5.1.6 More Information / where to buy tools

For more informations on tools, have a look at our internet site (www.vhf.de) and the vhf Tool-Shop (www.carbide-tools.com) or the vhf Tool-Catalogue.

All of the tools you buy at vhf, come with detailed information on how to use this specific tool at it's best.

- <http://www.carbide-tools.com>
- <http://www.vhf.de>

The carbide tool online shop offers an online tool calculation which calculates the basic parameters for your tool and material. Feel free to use this free service.

5.2 Files and directories**5.2.1 Cenon program**

The program file of Cenon is located in the application directory of your computer system:

Apple: /Applications/Cenon.app

GNUstep: /usr/GNUstep/Local/Applications/Cenon.app

OpenStep: /LocalApps/Cenon.app

5.2.2 Library

In the Library path of Cenon you can find examples, projects and all the things which are intended to be customized (configurations, data files, etc.). Cenon has a global Library path shared between all users, which is not writable to a user, and a local Library path inside the home directory (here HOME) of the user:

Apple: /Library/Cenon

 HOME/Library/Cenon

GNUstep: /usr/GNUstep/Local/Library/Cenon

 HOME/GNUstep/Library/Cenon

OpenStep: /LocalLibrary/Cenon

 HOME/Library/Cenon

Files can appear in both Library paths (the global library path and the home library path). In this case the file in the home library path has priority. This allows a user to modify a configuration file without changing the installation of Cenon.

In the following we describe the most important files and directories. All located in the HOME-Library of Cenon:

File / Folder	Description
Projects	Your Cenon projects and examples
Examples	Some examples of import formats
Devices/din/*.dev	Configuration files for the drill data import
Devices/gerber/*.dev	Configuration files for the Gerber import
Devices/hppl/*.dev	Configuration files for the HPGL import
Devices/xyz/*.dev	The device configuration files
CAM	Folder for special configurations
CAM/Jobs	Your CAM projects and example projects
CAM/positions	ASCII file holding the position memory
CAM/magazine	ASCII file holding the tool magazine

Cenon provides two folders for projects (Projects and CAM-Jobs). There is no technical differences between the file format.

5.3 Error and Warning Messages

- **Select two objects for joining!**

You have to select two objects to be able to join them and create a path object.

- **Can't create backup file. File not saved!**

Check if you have write permission to the directory and the Cenon file you tried to write.

- **Could not open file FILENAME.**

Check the read permissions on the file FILENAME, and on the directory it is located in. You need read permissions on a file to open it. Another possibility is that the file is corrupted or of a format Cenon is not capable to read. Check for other messages in the Console.

- **Could not open file FILENAME. Using Default.**

Here Cenon tells you that it can't read FILENAME, and uses default values instead.

- **You have unsaved documents!**

If you quit Cenon and have unsaved documents, this message appears to give you a chance to save the files. You can review the unsaved files or quit anyway.

- **Can't write file.**

Check the write permissions on the directory you try to save in. Also check if there already is a file which you are not allowed to overwrite.

- **FILENAME has changes. Save ?**

This warning message appears if you try to close a window of a document which hasn't been saved yet. You have the choice to save the file or close it anyway.

- **Do you want to revert to: FILENAME ?**

This is a safety message giving you a chance to cancel your request to reload a file and lose all your changes.

- **This Operation will force a recalculation of the graphic!**

Cenon gives you a chance to cancel the operation or will start a recalculation.

- **This Operation can take a while!**

You are warned that the following operation will take some time and you have to wait until has been finished. This message does not appear in expert mode.

- **The contour will be calculated now! You may want to stop this operation to calculate on a later time.**

You are warned that the output tracks needs recalculation and you are given a chance to calculate them on a later time. This message does not appear in expert mode.

- **Layer LAYERNAME needs recalculation!**

If you start the output and the output tracks of some layers are not calculated yet, Cenon gives you a chance to cancel and take a look at the tracks before you start output. Otherwise the output is calculated and executed directly.

- **No data to process!**

You started the output without any data to process.

- **Couldn't locate tool name TOOLNAME in magazine! You may have removed the tool since your last session.**

You have tools assigned to a layer of your job which is not in the active magazine. Check the magazines for the needed tool or select a new tool from the pop up menu.

- **Name 'NAME' already in use!**

If you add or rename a layer or position this message can appear. You should rename the existing layer or choose a different name for the new one if possible.

- **You need to install the Cenon Library!**

Some Library files are missing. On OpenStep the Library of Cenon has an extra package. Most likely you haven't installed it.

- **Only one layer of this kind allowed!**

Cenon allows only one layer of the kinds: Fitting-Layer, Clipping-Layer, or Levelling-Layer.

- **Only one position for parking allowed!**

This shouldn't happen at all, but somehow you tried to add a second layer for the parking positioning. This is not possible.

- **Only a single rectangle allowed on leveling layer!**

You created graphic objects on the leveling layer which are not allowed there. Delete everything but a single rectangle.

- **This Operation will remove the fill layer attached to the Pick Out!**

The Pick-Out owns a second layer. If you leave the correction for a Pick-Out this layer is removed.

- **Automatic adjust! Be sure to have placed the surface sensor correctly, before pressing 'Start'.**

If your machine allows automatic measuring of the tool offset, this message gives you a chance to place the switch under the tool before it starts the operation.

- **Do you really want to remove the current magazin?**

A warning message telling you that you are about to remove an entire magazine.

- **Set Magazin: This operation will remove all tools from layers!**

A warning message telling you that you have to assign a new tool to all your layers, if you select a new magazine. You have the chance to cancel your request.

- **Stop work?**

A warning message. It appears when you click on Stop while the output is running. The Z axis is lifted and you have a chance to check things, before you continue or stop the output.

- **Graphic out of range!**

Your graphic is located outside of the machine table. Be sure that the graphic you want to process is completely inside the gray lines, representing the machine table. You have a chance to continue, but this can lead to an incomplete output of your graphic.

- **Please log in as root!**

Licensing only works as user root.

More messages can appear in the Console window (or system log file). Especially messages during calculation of the output path are listed there.

On Linux this file can be found in the menu of the Window Manager under *Info* ▷ *System Console*. On OpenStep it can be found in *Tools* ▷ *Console* of the Workspace Manager.

5.4 Keyboard Commands

Control-Panel:

Within the CAM control panel you have the following key commands available:

arrow up (8)	moves the y-axis in positive direction
arrow down (2)	moves the y-axis in negative direction
arrow right (6)	moves the x-axis in positive direction
arrow left (4)	moves the x-axis in negative direction
arrow up (9)	lift the z-axis
arrow down (3)	lower the z-axis
Ctrl (keep pressed)	move in 1.0 mm steps

Editing, Selecting

The keys Alt, Shift, and Ctrl can be used in combination with the mouse. The meaning of these combinations can be found in the description of each mouse action. See section ??.

Menu keys:

On Apple you have to use the Apple-Key instead of the Alt key !

Command	Key word	Description
Alt-a	all	Select all
Alt-A	Area	Show Working Area panel
Alt-b	bold	Change selected text to bold
Alt-B	Batch	Batch Production
Alt-c	copy	Copy selected objects into buffer
Alt-C	Color	Show Color-Panel
Alt-d	direction	Revert direction

Alt-D	Direction	Display directions of objects
Alt-e	equal	Select equal objects
Alt-F	Form	Show Transform-Panel
Alt-g	group	Group selected objects
Alt-G	unGroup	Ungroup selected groups
Alt-h	hide	Hide program
Alt-i	iItalic	Change selected text to italic
Alt-I	Inspector	Show Inspector-Panel
Alt-j	join	Join selected objects
Alt-J	unJoin	Split joined objects (Path, Textpath, clipped Image)
Alt-m	mirror	Mirror selected objects
Alt-M	Moves	Show output tracks
Alt-n	new	Create new document
Alt-o	open	Open (Load) document
Alt-O	Optimize	Optimize moves
Alt-p	print	Print document
Alt-P	Page	Show Page-Layout panel
Alt-q	quit	Quit program
Alt-r	rotate	Rotate selected objects by 90°
Alt-R	Ruler	Toggle text ruler
Alt-s	save	Save document
Alt-S	Save as	Save document with new name
Alt-t	text	Show Font-Panel
Alt-T	Tool	Display tool diameter
Alt-u	unsave	Revert to saved document
Alt-U	pUnch	Punch selected objects
Alt-v	view	Paste buffer into document
Alt-w	window	Close window
Alt-x		Cut selected objects into buffer
Alt-z		Undo
Alt-Z		Redo
Alt-?	?	Help

Alt-1		Graphic-Inspector, when editing text: Copy ruler
Alt-2		Width-Inspector, when editing text: Paste ruler
Alt-3		Fill-Inspector, when editing text: Copy font
Alt-4		Texttype-Inspector, when editing text: Paste font
Alt-5		Layer-Inspector
Alt-8		Bring to front
Alt-(Bring one object further to the front
Alt-9		Send to back
Alt-)		Send one object further to the back
Alt-#		Toggle grid
Alt-Shift-#		Show Grid Panel
Alt-<		align text to the left
Alt-		center text
Alt->		align text to the right

5.5 Frequently asked Questions

For an up-to-date version of the questions and answers visit the internet pages of Cenon www.Cenon.info.

5.5.1 CAM

The tool radius is corrected more than expected

Newer versions of Cenon include the stroke width when correcting the tool radius. You can set the stroke width of an object to 0 using the Inspector.

The tool radius isn't corrected

You have to fill your graphic objects to allow a tool radius correction.

Some characters have ugly spars in their output path

Your data contains lines or curves which are smaller than the tool radius. You should remove these elements from your graphic. As an alternative you can switch to the bitmap (raster) algorithm of Cenon (preferences option).

For my newly generated tool, the tool correction does the wrong thing or nothing at all

Check the type of the tool (the pop up menu in the tool parameter panel). If you want to cut you shouldn't set the type of a drill for example!

5.5.2 CAM Production**The wrong configuration file is used**

Probably your configuration file was found on a second place with the same name. Device configuration files basically can reside in two places in the file system:

1. HOME/Library/Cenon/Devices/xyz (HOME is your home directory)

2. /LocalLibrary/Cenon/Devices/xyz

or for Linux:

/usr/GNUstep/Local/Library/Cenon/Devices/xyz

Configuration files in the first directory have priority and will be used if a file with the same name resides in the second directory. This allows a user to modify a configuration file without changing the installation of Cenon.

The spindle doesn't start automatically or isn't controlled by the application at all

Check the preferences of Cenon, if the correct machine type with support of your spindle is used.

After updating Cenon, the machine doesn't work any more

Check the preferences of Cenon to use the right type of machine.

The machine jerks sometimes and give bad results.

If you get an offset in your output (sometimes always at the same position), then probably the positioning speed is too high and has to be lowered.

Not everything is send to the machine, even with all the eyes open in the CAM-Panel

Go to the Control-Panel (CAM-Panel, Control) and set the radio button from "Selection" to "All".

The machine stops in the middle of the output (there appear messages in the console window of the Workspace), or the machine moves to wrong positions

Probably you experience an EMV problem of the PC, and disturbances come in over the serial interface. You should use a shielded serial cable (please use the cable coming with the machines of vhf). Connect your PC on a seperate plug than for example the vakuum cleaner. Also the use of a seperate serial card may help. Usually a small company don't have to buy an expensive industry PC to get rid of those problems.

CNC 450: If I stop during output, the machine stops with delay

Cenon has to send some vectors in advance to the controller, so the machine can't stop before processing those vectors. To shorten the delay, you can modify the maximum size of lines in the layer details section of the CAM-Panel.

Apple: the output is frozen and Cenon too

Plug out the serial adaptor from the USB interface for a short time. This will bring back the controls. You are using a device configuration which uses a tty device (entry #DEV) and you haven't connected a device (or have connected a device which doesn't fit the configuration). To prevent future freezing, you can change the device entry of your device configuration to use a cu device. To do this open the device configuration in a text editor and change the device entry (#DEV) from tty to cu (see section 4.2).

5.6 Serial Cable

To connect your machine or plotter to the computer you need a serial cable. If you get a machine from vhf, you get a cable with your machine. You should use this cable.

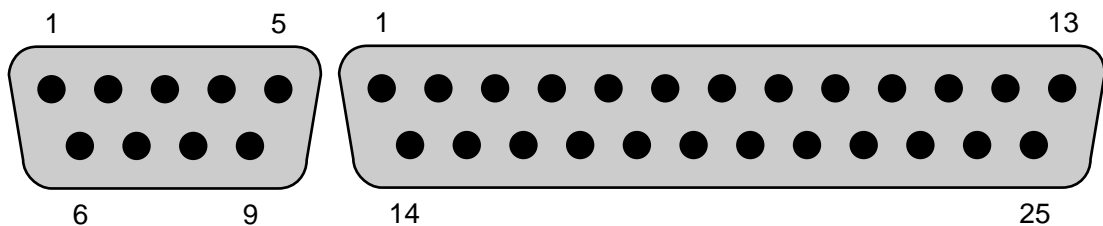

The images show the pin numbering for male SUB-D connectors. You find them on the PC side of the connection as well as on a serial adaptor (Apple). The female connectors are numbered in reverse order.

This is the general pin layout of the serial connectors on PCs and most serial devices (this is true for male and female connectors):

9 pin	25 pin	Pin Name	Pin Description
1	8	DCD	Data Carrier Detect
2	3	RXD	Receive Data
3	2	TXD	Transmit Data
4	20	DTR	Data Terminal Ready
5	7	GND	Signal Ground
6	6	DSR	Data Set Ready
7	4	RTS	Ready To Send
8	5	CTS	Clear To Send

The cable for connecting a plotter and some CNC controllers needs the following connections to work with all handshakes. See the manual for your specific device for further information.

PC	Plotter
RXD	TXD
TXD	RXD
RTS	CTS
CTS	RTS
GND	GND
DCD	DTR
DTR	DCD
DCD	DSR

5.7 Glossary

"What does this mean?" is sometimes the question. This glossary should help you to better understand technical terms and also give you a short explanation to important terms from A (aperture table) to Z (Zenon). If more information is available in the manual we will refer to the appropriate section of the manual.

Aperture Table	A aperture table is necessary for importing Gerber files. This file contains all the necessary D-code information to assign the aperture of the photo-plotter (soldering point shape, sizes and conductor path thickness) to the different layout elements of your CAD-program. The aperture table used for export has to be used for importing as well. The extended Gerber format doesn't need an aperture table any more.
Blow Up	Special kind of isolation tracks for producing PCB prototypes. A blow up is used to increase the isolation paths for easier soldering.
CNC-Controller	The CNC controller is the link between your computer unit and the engraving unit. The controller converts the signals send by Cenon to signals of higher electrical current, so that they are able to power the different axes of the engraving unit.
Configuration file	In your configuration file (extension .dev) control commands and other parameter for the output device are defined or different commands of the different import formats are translated for Cenon.Default A default is an entry preset by an application.
Conical	Conical describes a shape which goes from wide to narrow.
Inlay	Inlays are a special case of cutting material, so that one poarts fits exactly into another.
Excellon Format	Excellon is a data format used by industrial drilling machines for drilling holes in circuit boards. Many of the CAD programs can export these data and enable you to import all the drilling information. The format is imported using the DIN import.

Extended Gerber	This is an improved Gerber format without the need of a separated Aperture file. The format also allows complex ground planes, which is very important for a clean import of the data.
Gerber-Format	Gerber is a data format for exporting layout data. In general, photo-plotter use this file format. Because this file format is very common, most of the CAD-programs are able to create files in this format.
HPGL	This abbreviation is an acronym for "Hewlett Packard Graphics Language" and is one of the well know and mostly used command set for accessing pen plotter.
Inner Contour	The inner contour is mainly used for calculating the engraving path of filled areas. The appropriate tool is labeled engraving tool.
Insulation engraving	Special kind of tool radius correction used to create prototypes of printed circuit boards (PCBs). The insulation is engraved around the tracks.
Outer Contour	The calculation of the outer contour of components is necessary, if the elements have to be cut-out totally and the cut out should comply exactly with the layout of the element. These cut-outs are normally done with a milling tool.
Outline-Algorithm	The outline-algorithm is responsible for creating a contour around graphic objects.
Pick-Out	The pick out is a special method of creating output for detailed engraving purposes. It is used with a conical tool.

PostScript	PostScript is a vector based page description, which is mainly used in the DTP area. This format is normally used to drive photo-type-setters to create inexpensive film layouts.
Project	A project in Cenon is your document file. It is saved with the extension '.cenon'. In CAM applications a Cenon project can also be called a job.
Rub-Out	Rub-out area (especially PCB prototyping) indicates areas where analog to the chemical process the conduction copper material is completely removed (important for HF-applications). The actual tool diameter is used for calculation of the appropriate path to completely remove all the copper.
Sieb & Meyer	Sieb & Meyer is an industrial drill data format. The two Sieb & Meyer formats (1000 and 3000) can be imported using the DIN import.
Spindle	Also called HF- or SF-spindle. Using high frequency three-phase current, extremely high revolutions per minute (RPM) can be generated, to achieve a precise output and a high feeding speed.
Cenon	Universal construction and production software.

Index

- Acute angle, [35](#)
- Answers (FAQ), [110](#)

- Barcode (Menu), [46](#)
- Barcode-Import, [77](#)
- Batch Production (Menu entry), [49](#)
- Bring To Front (Menu entry), [47](#)

- Cable (Serial), [113](#)
- CAM (Preferences), [44](#)
- CAM-Panel, [51](#)
- CAM-Panel (Menu entry), [49](#)
- Chamfering (Preferences), [46](#)
- Change Feed (Control-Panel), [67](#)
- Change Revolution (Control-Panel), [67](#)
- Circular (Image-Inspector), [40](#)
- Clipping layer (Layer-Details), [57](#)
- Clipping-Layer, [70](#)
- CNC-Controller (Configuration), [84](#)
- Configuration files, [81](#)
- Console, [107](#)
- Contour fill (Preferences), [45](#)
- Control-Panel, [65](#)

- Device (Preferences), [44](#)
- Device configuration, [84](#)
- Directories, [102](#)

- Error messages, [104](#)

- FAQ, [18](#), [110](#)
- Features (CAM), [9](#)
- Files, [102](#)
- Fitting-Layer, [75](#)
- Flight level (Control-Panel), [66](#)
- Format (Menu), [47](#)

- History, [8](#)

- Import ASCII (Menu), [47](#)
- Installation, [13](#)

- Keyboard Commands, [108](#)

- Layer detail, [56](#)
- Layers, [69](#)
- Leveling (device configuration), [94](#)
- Levelling, [76](#)
- Library, [103](#)
- Licensing, [16](#)
- Linear (Image-Inspector), [40](#)
- Logarithmic (Image-Inspector), [40](#)

- Machine Control, [65](#)
- Magazine-Panel, [60](#)
- Mailing list, [18](#)

- Maximum diameter, [35](#)
- Menu keys, [108](#)
- Menus, [46](#)
- Messages, [104](#)
- Move height (Control-Panel), [66](#)
- online tool calculation, [102](#)
- Optimize Moves (Menu entry), [48](#)
- Optimize moves (Preferences), [45](#)
- Panelling, [70](#)
- Parking Position (Preferences), [45](#)
- Pick Out, [34](#)
- Positioning Memory, [68](#)
- Preferences, [43](#)
- Questions (FAQ), [110](#)
- Raster algorithm (Preferences), [45](#)
- Relief, [40](#)
- Save Output (Menu entry), [47](#)
- Send To Back (Menu entry), [47](#)
- Serial cable, [113](#)
- Serial number (Preferences), [45](#)
- Sub-D, [113](#)
- Support, [18](#)
- Surface Measurement (device configuration), [94](#)
- Tangential knife (device configuration), [95](#)
- Teach-In-Panel (Menu entry), [49](#)
- Test points (Levelling), [76](#)
- Tool Management, [60](#)
- Tool measurement, [76](#)
- Tool-Parameters, [61](#)
- Tools (CAM), [97](#)
- Type of layer (Layer-Details), [57](#)
- USB adaptor, [14](#)
- Warning messages, [104](#)
- Working Area, [48](#)
- WWW, [18](#)